



SPECIFICATION SHEET

SPECIFICATION SHEET NO.	N1004- SOD323LC12CSDC
DATE	Oct. 04, 2021
REVISION	A0
DESCRIPTION	<p>SMD Plastic-Encapsulate ESD Protection Diodes, SOD-323 series, 2 pads GBLC12C Type, Ultra Low Capacitance TVS Array Bi-directional Channels Reverse Working Voltage : 12V, Clamping Voltage 19VC Max.@1.0A</p> <p>Operating Temp. Range -55°C ~+150°C, Package in Tape/Reel, 3000pcs/Reel RoHS/RoHS III compliant</p>
CUSTOMER	
CUSTOMER PART NUMBER	
CROSS REF. PART NUMBER	
ORIGINAL PART NUMBER	MDD GBLC12C
PART CODE	SOD323LC12CSDC

VENDOR APPROVE			
Issued/Checked/Approved			
DATE: Oct. 04, 2021			

CUSTOMER APPROVE	
DATE:	

SMD ESD PROTECTION DIODES SOD-323 SERIES

MAIN FEATURE

- Peak power dissipation 300W (8/20μs)
- IEC61000-4-2 (ESD) ±15kV (air), ±8kV (contact)
- IEC61000-4-4 (EFT) 40A (5/50ns)
- IEC61000-4-5 (Lightning) 12A (8/20μs)
- Protects one data I/O line (Bi-directional)
- Low clamping voltage
- Low leakage current
- Working Voltage 3V/5V/8V/12V/15V/24V
- Response Time is less than 1 ns
- Meet MSL 1 requirement



APPLICATION

- Cell phone handsets and accessories
- Notebooks, Desktops, and Servers Cellular
- Microprocessor based equipment
- USB Interface
- Portable Instrumentation
- Personal Digital Assistants (PDA's)
- Peripherals

RFQ

[Request For Quotation](#)

PART CODE GUIDE

SOD323	LC12C	S	DC
1	2	3	4

- 1) **SOD323**: SMD Plastic-Encapsulate ESD Protection Diodes, SOD-323 series, 2 pads
- 2) **LC12C**: Type code for original part number GBLC12C
- 3) **S**: Package code, Package in Tape/Reel, 3000pcs/Reel
- 4) **DC**: Marking code for "DC "on the case surface, Different Marking for different specification.

SMD ESD PROTECTION DIODES SOD-323 SERIES

DIMENSION (Unit: Inch/mm)

Image for reference



Marking: DC

SOD-323

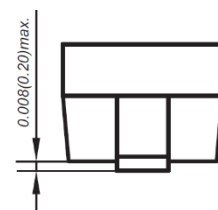
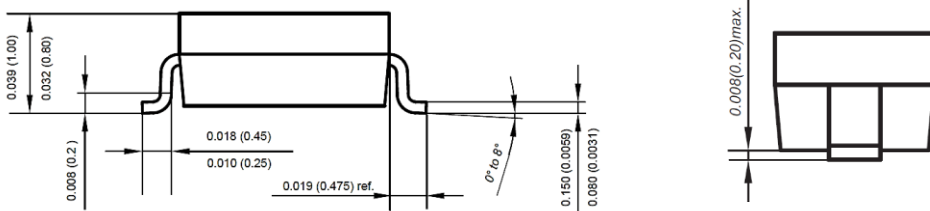
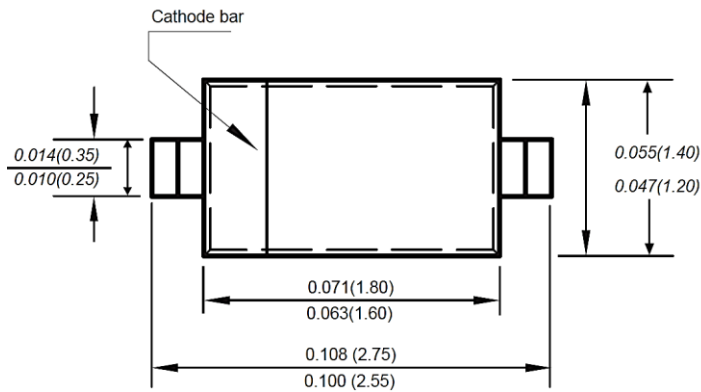

Recommend Pad Layout

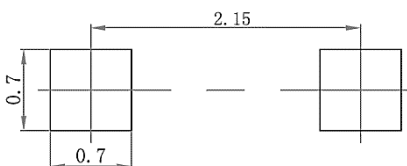

Circuit Diagram

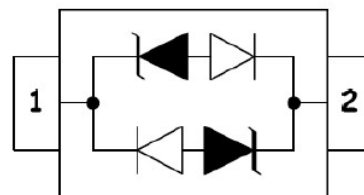

SMD ESD PROTECTION DIODES SOD-323 SERIES
MECHANICAL DATA

Case	Flammability Rating	Terminals	Mounting Position	Weight per piece
JEDEC SOT-323 molded plastic body	UL 94V-0	Matte tin plated	-	-

ABSOLUTE MAX. RATINGS AT Ta=25 °C (unless otherwise specified)

Parameter	SYMBOLS	VALUE	UNITS
		LIMIT	
ESD per IEC 61000-4-2 (Air)	V _{ESD}	+/-15	KV
ESD per IEC 61000-4-2 (Contact)	V _{ESD}	+/-8	KV
Peak Pulse Power @8/20µs	P _{PP}	300	W
Operating Temperature Range	T _J	-55 ~+ 150	°C
Storage Temperature Range	T _{STG}	-55 ~ +150	°C
Lead Solder Temperature- Max. (10 sec. Duration)	T _L	260 /10s	°C

SMD ESD PROTECTION DIODES SOD-323 SERIES
ELECTRICAL CHARACTERISTICS (Ta=25 °C unless otherwise specified)

Parameter	SYMBOLS	VALUE			UNITS
		Min.	Typical	Max.	
Reverse Working Voltage	V _{RWM}			12	V
Reverse Breakdown Voltage @ I _T = 1.0mA	V _{BR}	13.3			V
Reverse Leakage Current @ V _{RWM} = 12V	I _R			1.0	μA
Clamping Voltage @ I _{PP} = 1.0A, t _p = 8/20μs	V _C			19.0	V
Clamping Voltage @ I _{PP} = 6.0A, t _p = 8/20μs	V _C			28.6	V
Junction Capacitance @ V _R = 0V, f = 1MHz	C _T		0.8		pF

SMD ESD PROTECTION DIODES SOD-323 SERIES
RELIABILITY

Number	Experiment Items	Experiment Method And Conditions	Reference Documents
1	Solder Resistance Test	Test 260°C± 5°C for 10 ± 2 sec. Immerse body into solder 1/16" ± 1/32"	MIL-STD-750D METHOD-2031.2
2	Solderability Test	230°C ±5°C for 5 sec.	MIL-STD-750D METHOD-2026.1 0
3	Pull Test	1 kg in axial lead direction for 10 sec.	MIL-STD-750D METHOD-2036.4
4	Bend Test	0.5Kg Weight Applied To Each Lead, Bending Arcs 90 °C ± 5 °C For 3 Times	MIL-STD-750D METHOD-2036.4
5	High Temperature Reverse Bias Test	TA=100°C for 1000 Hours at VR=80% Rated VR	MIL-STD-750D METHOD-1038.4
6	Forward Operation Life Test	TA=25°C Rated Average Rectified Current	MIL-STD-750D METHOD-1027.3
7	Intermittent Operation Life Test	On state: 5 min with rated IRMS Power Off state: 5 min with Cool Forced Air. On and off for 1000 cycles.	MIL-STD-750D METHOD-1036.3
8	Pressure Cooker Test	15 PSIG, TA=121°C, 4 hours	MIL-S-19500 APPENOIXC
9	Temperature Cycling Test	-55°C~+125°C; 30 Minutes For Dwelled Time 5 minutes for transferred time. Total: 10 cycles.	MIL-STD-750D METHOD-1051.7
10	Thermal Shock Test	0°C for 5 minutes., 100°C for 5minutes, Total: 10 cycles	MIL-STD-750D METHOD-1056.7
11	Forward Surge Test	8.3ms Single Sale Sine-wave One Surge.	MIL-STD-750D METHOD-4066.4
12	Humidity Test	TA=65°C, RH=98% for 1000 hours.	MIL-STD-750D METHOD-1021.3
13	High Temperature Storage life Test	150°C for 1000 Hours	MIL-STD-750D METHOD-1031.5

SMD ESD PROTECTION DIODES SOD-323 SERIES

SUGGESTED REFLOW PROFILE (For Reference Only)

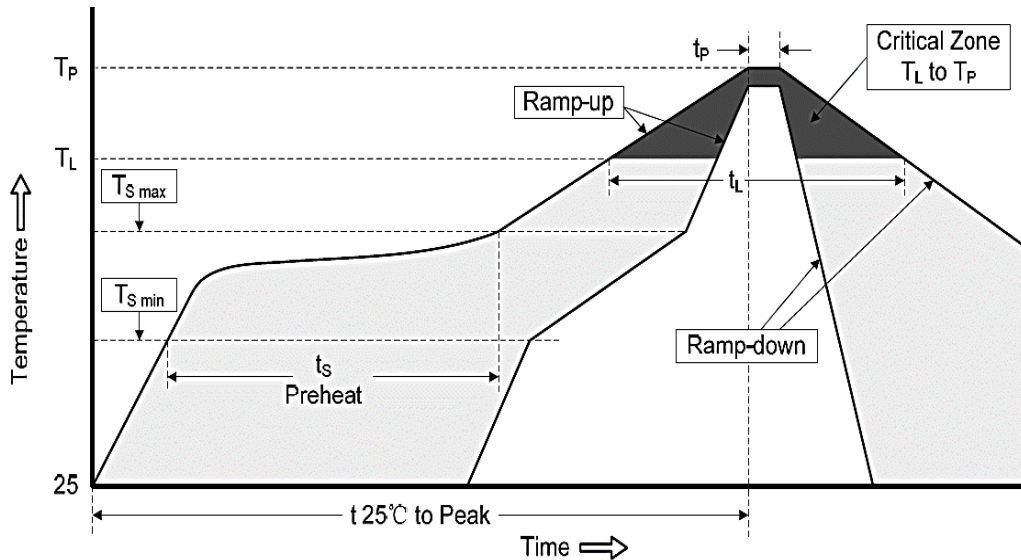

Profile Feature		Pb-Free Assembly
Average Ramp-up Rate (Ts Max to Tp)		3°C/second Max
Preheat	Temperature Min (Ts Min.)	150°C
	Temperature Max (Ts Max.)	200°C
	Time (ts Min. to ts Max.)	60 ~ 180 seconds
Time maintained above	Temperature (Tl)	217°C
	Time (ti)	60 ~ 150 seconds
Peak/Classification Temperature (Tp)		260 °C
Time within 5°C of actual Peak Temperature (tp)		20 ~ 40 seconds
Ramp-down rate		6 °C /Second Max.
Time 25 °C to Peak Temperature		8 minutes Max.
Suggest reflow times		3 Times Max.

SMD ESD PROTECTION DIODES SOD-323 SERIES

RATINGS AND CHARACTERISTIC CURVES (For Reference Only)

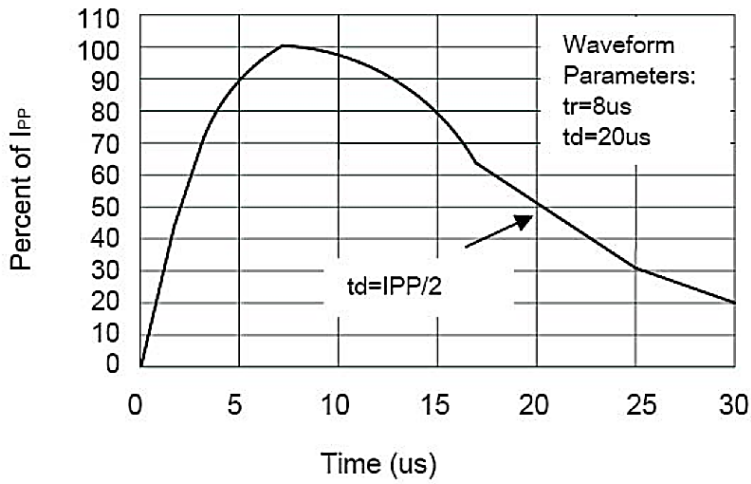

Pulse Waveform

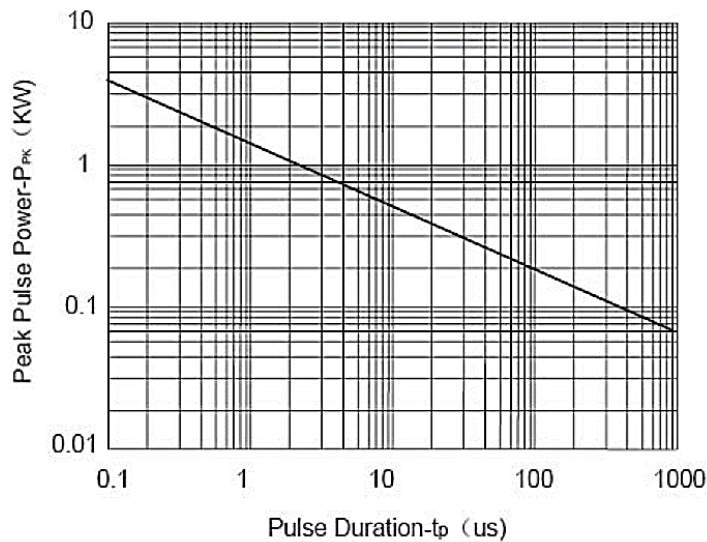

Non-Repetitive Peak Pulse Power vs. Pulse Time

SMD ESD PROTECTION DIODES SOD-323 SERIES

RATINGS AND CHARACTERISTIC CURVES (For Reference Only)

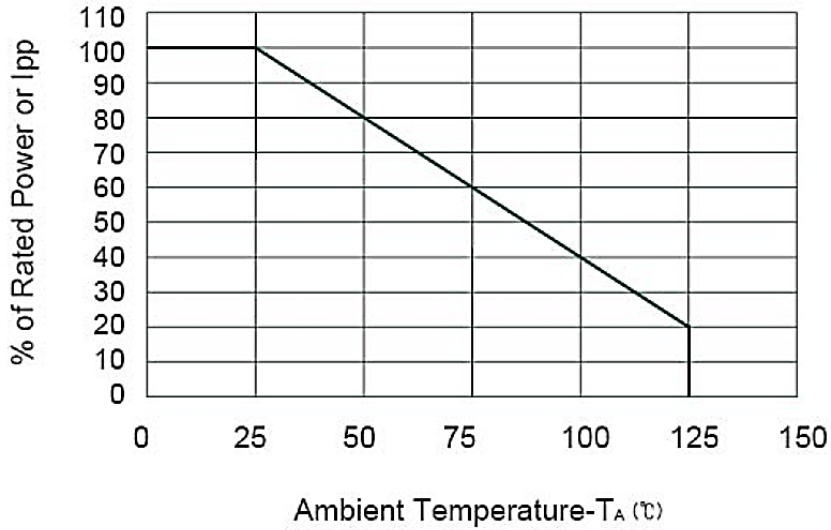

Power Derating Curve

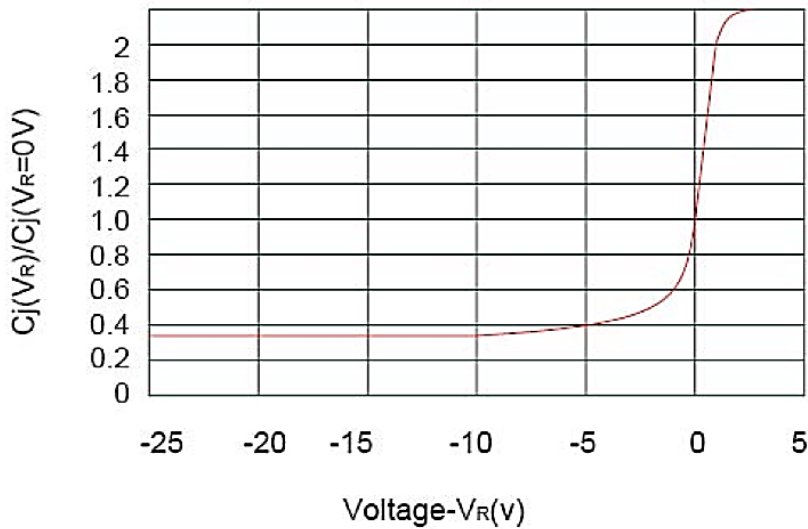

SMD ESD PROTECTION DIODES SOD-323 SERIES

TAPE/REEL (Unit: mm)

All Devices are packed in accordance with EIA standard RS-481-A and specifications.

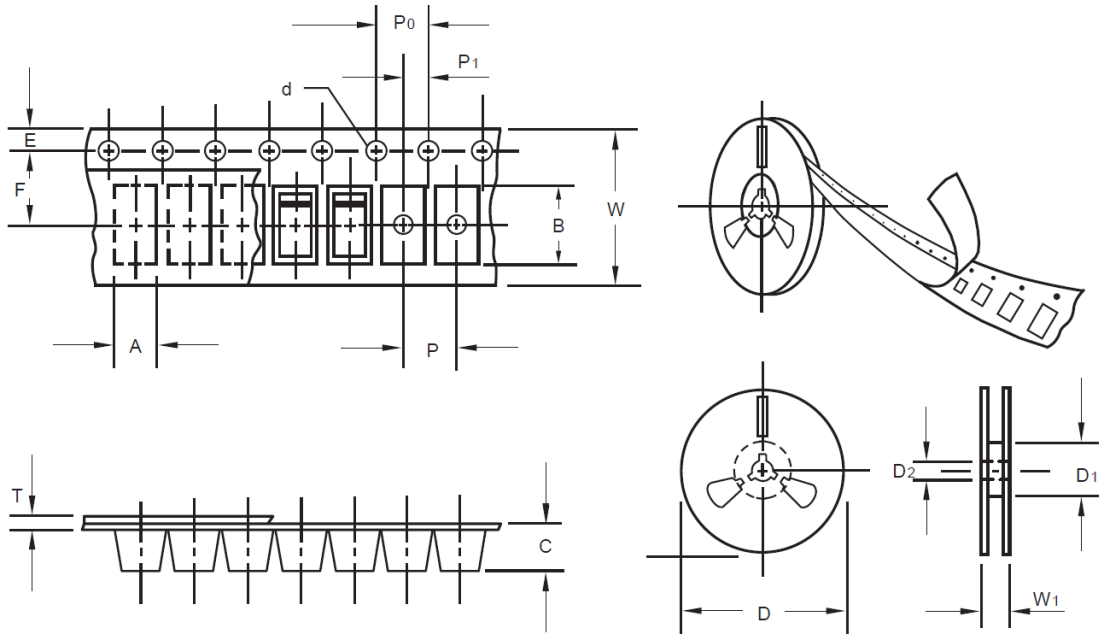

Item	Symbol	Tolerance	SO-323
Carrier width	A	0.1	1.46
Carrier Length	B	0.1	2.90
Carrier Depth	C	0.1	1.25
Sprocket hole	d	0.05	1.55
7"Reel outside diameter	D	2.0	178.00
7"Reel inner diameter	D1	Min.	50.00
Feed hole diameter	D2	0.5	13.00
Sprocket hole position	E	0.1	1.75
Punch hole position	F	0.1	3.50
Punch hole pitch	P	0.1	4.00
Sprocket hole pitch	P0	0.1	4.00
Embossment center	P1	0.1	2.00
Overall tape thickness	T	0.1	0.06
Tape width	W	0.3	8.00
Reel width	W1	1.0	12.30

SMD ESD PROTECTION DIODES SOD-323 SERIES

SPQ PACKAGE for Reference

Item	Unit	Value
Case Code		SOD-323
Reel Size	Inch	7
Reel Size	mm	178
Tape Space	mm	/
SPQ /Reel	pcs	3000
Weigh /SPQ	LBS	-
Weigh /SPQ	KGs	-
Qty. Per Box	pcs	6,000
Inner Box	Inch	L8.0*W8.0*H1.5

DISCLAIMER

NextGen Component, Inc. reserves the right to make changes to the product(s) and or information contained herein without notice. No liability is assumed as a result of their use or application. No rights under any patent accompany the sale of any such product(s) or information