

TPS2597xx 2.7 V–23 V, 7-A, 9.8-mΩ eFuse With Accurate Current Monitor and Transient Overcurrent Blanking

1 Features

- Wide operating input voltage range: 2.7 V to 23 V
 - 28-V absolute maximum
- Integrated FET with low on-resistance: $R_{ON} = 9.8 \text{ m}\Omega$ (typ.)
- Fast overvoltage protection
 - Overvoltage clamp (OVC) with pin-selectable threshold (3.89 V, 5.76 V, 13.88 V) and 5- μs (typical) response time or
 - Adjustable overvoltage lockout (OVLO) with 1.2- μs (typical) response time
- Overcurrent protection with load current monitor output (ILM)
 - Active current limit or circuit-breaker options
 - Adjustable threshold (I_{LIM}) 0.87 A – 7.7 A
 - $\pm 10\%$ accuracy for $I_{LIM} > 1.74 \text{ A}$
 - Adjustable transient blanking timer (ITIMER) to allow peak currents up to $2 \times I_{LIM}$
 - Output load current monitor accuracy: $\pm 8\%$ (max)
- Fast-trip response for short-circuit protection
 - 550-ns (typical) response time
 - Adjustable ($2 \times I_{LIM}$) and fixed thresholds
- Active high enable input with adjustable undervoltage lockout threshold (UVLO)
- Adjustable output slew rate control (dVdt)
- Overtemperature protection
- Digital outputs
 - Fault indication ($\overline{\text{FLT}}$) or
 - Power-Good indication (PG) with adjustable threshold (PGTH)
- UL 2367 recognition
 - File No. E339631
 - $R_{ILM} \geq 750 \Omega$
- IEC 62368-1 CB certified
- Small footprint: QFN 2 mm \times 2 mm, 0.45-mm pitch

2 Applications

- [Server, PC motherboard, and add-in cards](#)
- [Enterprise storage – RAID/HBA/SAN/eSSD](#)
- [Patient monitors](#)
- [Appliances and power tools](#)
- [Retail point-of-sale terminals](#)
- [Smartphones and tablets](#)

3 Description

The TPS2597xx family of eFuses is a highly integrated circuit protection and power management solution in a small package. The devices provide multiple protection modes using very few external components and are a robust defense against overloads, short-circuits, voltage surges and excessive inrush current.

Output slew rate and inrush current can be adjusted using a single external capacitor. Loads are protected from input overvoltage conditions either by clamping the output to a safe fixed maximum voltage (pin selectable), or by cutting off the output if the input exceeds an adjustable overvoltage threshold. The devices respond to output overload by actively limiting the current or breaking the circuit. The output current limit threshold as well as the transient overcurrent blanking timer are user adjustable. The current limit control pin also functions as an analog load current monitor.

The devices are available in a 2-mm \times 2-mm, 10-pin HotRod™ QFN package for improved thermal performance and reduced system footprint.

The devices are characterized for operation over a junction temperature range of -40°C to $+125^\circ\text{C}$.

Package Information

PART NUMBER	PACKAGE ⁽¹⁾	BODY SIZE (NOM)
TPS2597xxRPW	RPW (QFN, 10)	2.00 mm \times 2.00 mm

- (1) For all available packages, see the orderable addendum at the end of the data sheet.

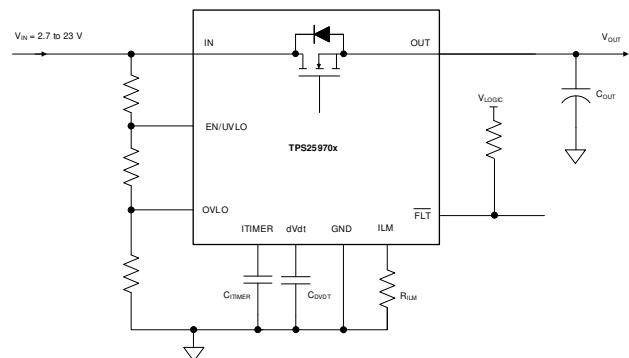

Simplified Schematic



Table of Contents

1 Features	1	8.3 Feature Description.....	22
2 Applications	1	8.4 Device Functional Modes.....	33
3 Description	1	9 Application and Implementation	34
4 Revision History	2	9.1 Application Information.....	34
5 Device Comparison Table	3	9.2 Typical Application.....	35
6 Pin Configuration and Functions	4	9.3 Parallel Operation.....	38
7 Specifications	5	9.4 Power Supply Recommendations.....	40
7.1 Absolute Maximum Ratings.....	5	9.5 Layout.....	42
7.2 ESD Ratings.....	5	10 Device and Documentation Support	44
7.3 Recommended Operating Conditions.....	5	10.1 Device Support.....	44
7.4 Thermal Information.....	6	10.2 Documentation Support.....	44
7.5 Electrical Characteristics.....	7	10.3 Receiving Notification of Documentation Updates.....	44
7.6 Timing Requirements.....	8	10.4 Support Resources.....	44
7.7 Switching Characteristics.....	9	10.5 Trademarks.....	44
7.8 Typical Characteristics.....	10	10.6 Electrostatic Discharge Caution.....	44
8 Detailed Description	18	10.7 Glossary.....	44
8.1 Overview.....	18	11 Mechanical, Packaging, and Orderable Information	45
8.2 Functional Block Diagram.....	19		

4 Revision History

NOTE: Page numbers for previous revisions may differ from page numbers in the current version.

Changes from Revision B (January 2022) to Revision C (April 2023)	Page
• Updated the UL/IEC certification status.....	1
Changes from Revision A (December 2021) to Revision B (January 2022)	Page
• Added <i>Thermal Information</i> table to the document.....	5
Changes from Revision * (November 2021) to Revision A (December 2021)	Page
• Changed status from "Advance Information" to "Production Data".....	1

5 Device Comparison Table

PART NUMBER	OVERVOLTAGE RESPONSE	OVERCURRENT RESPONSE	PG and PGTH	FLT	RESPONSE TO FAULT
TPS25970ARPW	Adjustable OVLO	Active Current Limit	N	Y	Auto-Retry
TPS25970LRPW					Latch-Off
TPS25972ARPW	Pin Selectable OVC (3.89 V/5.76 V/13.88 V)		Y	N	Auto-Retry
TPS25972LRPW					Latch-Off
TPS25974ARPW	Adjustable OVLO	Circuit Breaker			Auto-Retry
TPS25974LRPW					Latch-Off

6 Pin Configuration and Functions

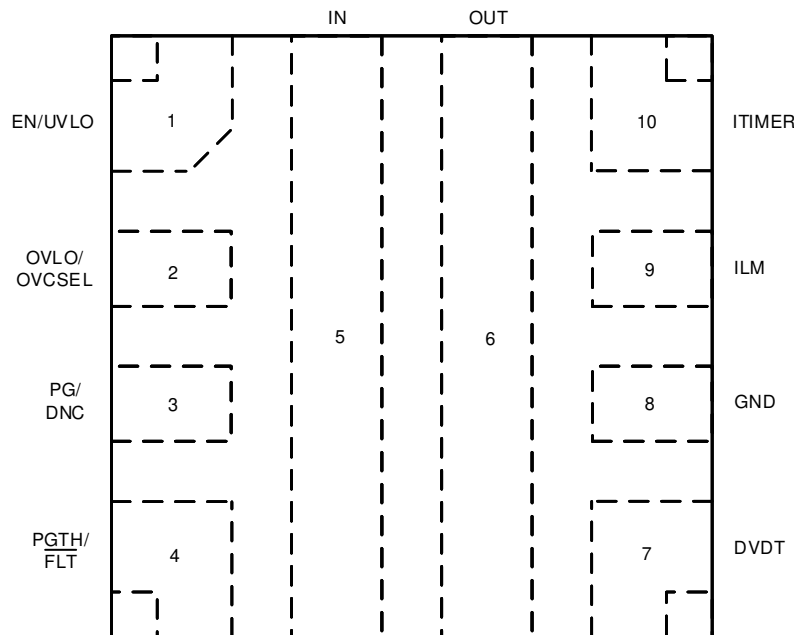

Figure 6-1. TPS2597xx RPW Package 10-Pin QFN (Top View)

Table 6-1. Pin Functions

PIN		TYPE	DESCRIPTION
NAME	NO.		
EN/UVLO	1	Analog Input	Active high enable for the device. A resistor divider on this pin from input supply to GND can be used to adjust the undervoltage lockout threshold. <i>Do not leave floating.</i> Refer to Undervoltage Lockout (UVLO and UVP) for details.
OVLO	2	Analog Input	<i>TPS25970x and TPS25974x:</i> A resistor divider on this pin from supply to GND can be used to adjust the overvoltage lockout threshold. This pin can also be used as an active low enable for the device. <i>Do not leave floating.</i> Refer to Overvoltage Lockout (OVLO) for details.
OVCSEL		Analog Input	<i>TPS25972x:</i> Overvoltage clamp threshold select pin. Refer to Overvoltage Clamp (OVC) for details.
PG	3	Digital Output	<i>TPS25972x and TPS25974x:</i> Power-good indication. This is an open-drain signal, which is asserted high when the internal powerpath is fully turned ON and the PGTH input exceeds a certain threshold. Refer to Power Good Indication (PG) for more details.
DNC		Digital Output	<i>TPS25970x:</i> Can be left floating
FLT	4	Digital Output	<i>TPS25970x:</i> Active low fault event indicator. This pin is an open-drain signal that is pulled low when a fault is detected. Refer to Fault Response and Indication (FLT) for more details.
PGTH		Analog Input	<i>TPS25972x and TPS25974x:</i> Power-good threshold. Refer to Power Good Indication (PG) for more details.
IN	5	Power	Power input
OUT	6	Power	Power output
DVDT	7	Analog Output	A capacitor from this pin to GND sets the output turn on slew rate. Leave this pin floating for the fastest turn on slew rate. Refer to Slew Rate (dVdt) and Inrush Current Control for details.
GND	8	Ground	This pin is the ground reference for all internal circuits and must be connected to system GND.
ILM	9	Analog Output	This pin is a dual function pin used to limit and monitor the output current. An external resistor from this pin to GND sets the output current limit threshold during start-up as well as steady state. The pin voltage can also be used as analog output load current monitor signal. <i>Do not leave floating.</i> Refer to Circuit-Breaker or Active Current Limiting for more details.
ITIMER	10	Analog Output	A capacitor from this pin to GND sets the overcurrent blanking interval during which the output current can temporarily exceed set current limit (but lower than fast-trip threshold) before the device overcurrent response takes action. Leave this pin open for the fastest response to overcurrent events. Refer to Circuit-Breaker or Active Current Limiting for more details.

7 Specifications

7.1 Absolute Maximum Ratings

over operating free-air temperature range (unless otherwise noted)⁽¹⁾

Parameter		Pin	MIN	MAX	UNIT
V _{IN}	Maximum input voltage range, $-40\text{ °C} \leq T_J \leq 125\text{ °C}$	IN	-0.3	28	V
V _{OUT}	Maximum output voltage range, $-40\text{ °C} \leq T_J \leq 125\text{ °C}$	OUT	-0.3	V _{IN} + 0.3	
V _{OUT,PLS}	Minimum output voltage pulse (< 1 μ s)	OUT	-0.8		
V _{EN/UVLO}	Maximum Enable pin voltage range	EN/UVLO	-0.3	6.5	V
V _{OV}	Maximum OVCSEL/OVLO pin voltage range	OVCSEL/OVLO	-0.3	6.5	V
V _{dVdT}	Maximum dVdT pin voltage range	dVdT	Internally limited		V
V _{ITIMER}	Maximum ITIMER pin voltage range	ITIMER	Internally limited		V
V _{PGTH}	Maximum PGTH pin voltage range	PGTH	-0.3	6.5	V
V _{PG}	Maximum PG pin voltage range	PG	-0.3	6.5	V
V _{FLT\barB}	Maximum FLT pin voltage range	FLT \bar	-0.3	6.5	V
V _{ILM}	Maximum ILM pin voltage range	ILM	Internally limited		V
I _{MAX}	Maximum continuous switch current	IN to OUT	Internally limited		A
T _J	Junction temperature		Internally limited		°C
T _{LEAD}	Maximum lead temperature			300	°C
T _{stg}	Storage temperature		-65	150	°C

- (1) Operation outside the Absolute Maximum Ratings may cause permanent device damage. Absolute Maximum Ratings do not imply functional operation of the device at these or any other conditions beyond those listed under Recommended Operating Conditions. If used outside the Recommended Operating Conditions but within the Absolute Maximum Ratings, the device may not be fully functional, and this may affect device reliability, functionality, performance, and shorten the device lifetime.

7.2 ESD Ratings

			VALUE	UNIT
V _(ESD)	Electrostatic discharge	Human body model (HBM), per ANSI/ESDA/JEDEC JS-001 ⁽¹⁾	±2000	V
		Charged device model (CDM), per ANSI/ESDA/JEDEC JS-002 ⁽²⁾	±500	

- (1) JEDEC document JEP155 states that 500-V HBM allows safe manufacturing with a standard ESD control process.
(2) JEDEC document JEP157 states that 250-V CDM allows safe manufacturing with a standard ESD control process.

7.3 Recommended Operating Conditions

over operating free-air temperature range (unless otherwise noted)

Parameter		Pin	MIN	MAX	UNIT
V _{IN}	Input voltage range	IN	2.7	23 ⁽¹⁾	V
V _{OUT}	Output voltage range	OUT		V _{IN}	V
V _{EN/UVLO}	EN/UVLO pin voltage range	EN/UVLO		5 ⁽²⁾	V
V _{OV}	OVLO pin voltage range (TPS25970x and TPS25974x variants only)	OVLO	0.5	1.5	V
V _{dVdT}	dVdT pin capacitor voltage rating	dVdT	V _{IN} + 5 V		V
V _{PGTH}	PGTH pin voltage range	PGTH		5	V
V _{FLT\barB}	FLT pin voltage range	FLT		5	V
V _{PG}	PG pin voltage range	PG		5	V
V _{ITIMER}	ITIMER pin capacitor voltage rating	ITIMER	4		V
R _{ILM}	ILM pin resistance to GND	ILM	715	6650	Ω
I _{MAX}	Continuous switch current, $T_J \leq 125\text{ °C}$	IN to OUT		7	A
T _J	Junction temperature		-40	125	°C

- (1) For TPS25972x OVC variants, the input operating voltage must be limited to the selected Output Voltage Clamp Option as listed in the Electrical Characteristics section.

- (2) For supply voltages below 5 V, it is okay to pull up the EN pin to IN directly. For supply voltages greater than 5 V, TI recommends to use a resistor divider with a minimum pullup resistor value of 350 kΩ.

7.4 Thermal Information

THERMAL METRIC ⁽¹⁾		TPS2597xx	UNIT
		RPW (QFN)	
		10 PINS	
R _{θJA}	Junction-to-ambient thermal resistance	49.7 ⁽²⁾	°C/W
		71.8 ⁽³⁾	°C/W
R _{θJB}	Junction-to-board thermal resistance	15.7	°C/W
Ψ _{JT}	Junction-to-top characterization parameter	2.1 ⁽²⁾	°C/W
	Junction-to-top characterization parameter	1.3 ⁽³⁾	°C/W
Ψ _{JB}	Junction-to-board characterization parameter	23 ⁽²⁾	°C/W
		14.5 ⁽³⁾	°C/W

- (1) For more information about traditional and new thermal metrics, see the [Semiconductor and IC Package Thermal Metrics](#) application report.
- (2) Based on simulations conducted with the device mounted on a custom 4-layer PCB (2s2p) with 8 thermal vias under device.
- (3) Based on simulations conducted with the device mounted on a JEDEC 4-layer PCB (2s2p) with no thermal vias under device.

7.5 Electrical Characteristics

(Test conditions unless otherwise noted) $-40^{\circ}\text{C} \leq T_J \leq 125^{\circ}\text{C}$, $V_{\text{IN}} = 12\text{ V}$, $\text{OUT} = \text{Open}$, $V_{\text{EN/UVLO}} = 2\text{ V}$, $V_{\text{OVLO}} = 0\text{ V}$ for TPS25970x/4x, $\text{OVCSEL} = 390\text{ k}\Omega$ to GND for TPS25972x, $R_{\text{ILM}} = 715\ \Omega$, $dVdT = \text{Open}$, $\text{ITIMER} = \text{Open}$, $\overline{\text{FLT}} = \text{Open}$ for TPS25970x, $\text{PGTH} = \text{Open}$ for TPS25972x/4x, $\text{PG} = \text{Open}$ for TPS25972x/4x. All voltages referenced to GND.

Test Parameter	Description	MIN	TYP	MAX	UNITS
INPUT SUPPLY (IN)					
$I_{\text{Q(ON)}}$	IN supply quiescent current (TPS25970x)		413	650	μA
	IN supply quiescent current (TPS25972x)		407	650	μA
	IN supply quiescent current (TPS25974x)		413	650	μA
	IN supply quiescent current during OVC (TPS25972x)		429	650	μA
$I_{\text{Q(OFF)}}$	IN supply OFF state current ($V_{\text{SD(F)}} < V_{\text{EN}} < V_{\text{UVLO(F)}}$)		67	131	μA
I_{SD}	IN supply shutdown current ($V_{\text{EN}} < V_{\text{SD(F)}}$)		2.3	25	μA
$V_{\text{UVP(R)}}$	IN supply UVP rising threshold	2.44	2.54	2.64	V
$V_{\text{UVP(F)}}$	IN supply UVP falling threshold	2.35	2.45	2.55	V
OUTPUT VOLTAGE CLAMP (OUT) - TPS25972x					
V_{OVC}	Overvoltage Clamp threshold, OVCSEL = Shorted to GND	3.65	3.89	4.1	V
	Overvoltage Clamp threshold, OVCSEL = Open	5.25	5.76	6.2	V
	Overvoltage Clamp threshold, OVCSEL = 390 k Ω to GND	13.2	13.88	14.5	V
V_{CLAMP}	Output voltage during clamping, OVCSEL = Shorted to GND, $I_{\text{OUT}} = 10\text{ mA}$	3.2	3.82	4.2	V
	Output voltage during clamping, OVCSEL = Open, $I_{\text{OUT}} = 10\text{ mA}$	5	5.68	6.12	V
	Output voltage during clamping, OVCSEL = 390 k Ω to GND, $I_{\text{OUT}} = 10\text{ mA}$	13	13.79	14.6	V
OUTPUT LOAD CURRENT MONITOR (ILM)					
G_{IMON}	Analog load current monitor gain ($I_{\text{MON}} : I_{\text{OUT}}$), $1\text{ A} \leq I_{\text{OUT}} \leq 7.7\text{ A}$, $I_{\text{OUT}} < I_{\text{LIM}}$	98	105.5	114	$\mu\text{A/A}$
OVERCURRENT PROTECTION (OUT)					
I_{LIM}	Overcurrent threshold, $R_{\text{ILM}} = 6.65\text{ k}\Omega$	0.745	0.87	0.97	A
	Overcurrent threshold, $R_{\text{ILM}} = 3.32\text{ k}\Omega$	1.55	1.73	1.905	A
	Overcurrent threshold, $R_{\text{ILM}} = 1.65\text{ k}\Omega$	3.2	3.48	3.715	A
	Overcurrent threshold, $R_{\text{ILM}} = 750\ \Omega$	7.03	7.67	8.15	A
I_{SPFLT}	Circuit-Breaker threshold, ILM pin open (Single point failure)			0.1	A
I_{SPFLT}	Circuit-Breaker threshold, ILM pin shorted to GND (Single point failure)		2	3.1	A
I_{SCGain}	Scalable fast-trip threshold (I_{SC}) : I_{LIM} ratio	170	201	240	%
VFB	V_{OUT} threshold to exit current limit foldback	1.55	1.88	2.23	V
ON RESISTANCE (IN - OUT)					
R_{ON}	$2.7 \leq V_{\text{IN}} \leq 4\text{ V}$, $I_{\text{OUT}} = 3\text{ A}$, $T_J = 25^{\circ}\text{C}$		10	18.3	m Ω
	$4 < V_{\text{IN}} \leq 23\text{ V}$, $I_{\text{OUT}} = 3\text{ A}$, $T_J = 25^{\circ}\text{C}$		9.8	18.3	m Ω
ENABLE/UNDERVOLTAGE LOCKOUT (EN/UVLO)					
$V_{\text{UVLO(R)}}$	EN/UVLO rising threshold	1.183	1.2	1.228	V
$V_{\text{UVLO(F)}}$	EN/UVLO falling threshold	1.076	1.1	1.12	V
$V_{\text{SD(F)}}$	EN/UVLO falling threshold for lowest shutdown current	0.45	0.75	0.95	V
I_{ENLKG}	EN/UVLO pin leakage current	-0.1		0.1	μA
OVERVOLTAGE LOCKOUT (OVLO) - TPS25970x/4x					
$V_{\text{OV(R)}}$	OVLO rising threshold	1.183	1.2	1.228	V
$V_{\text{OV(F)}}$	OVLO falling threshold	1.076	1.1	1.12	V

7.5 Electrical Characteristics (continued)

(Test conditions unless otherwise noted) $-40^{\circ}\text{C} \leq T_J \leq 125^{\circ}\text{C}$, $V_{IN} = 12\text{ V}$, $\text{OUT} = \text{Open}$, $V_{EN/UVLO} = 2\text{ V}$, $V_{OVLO} = 0\text{ V}$ for TPS25970x/4x, $\text{OVCSEL} = 390\text{ k}\Omega$ to GND for TPS25972x, $R_{ILIM} = 715\ \Omega$, $dVdT = \text{Open}$, $\text{ITIMER} = \text{Open}$, $\overline{\text{FLT}} = \text{Open}$ for TPS25970x, $\text{PGTH} = \text{Open}$ for TPS25972x/4x, $\text{PG} = \text{Open}$ for TPS25972x/4x. All voltages referenced to GND.

Test Parameter	Description	MIN	TYP	MAX	UNITS
I_{OVLKG}	OVLO pin leakage current ($0.5\text{ V} < V_{OVLO} < 1.5\text{ V}$)	-0.1		0.1	μA
OVERCURRENT FAULT TIMER (ITIMER)					
I_{ITIMER}	ITIMER pin internal discharge current, $I_{OUT} > I_{LIM}$	1.5	2	2.72	μA
R_{ITIMER}	ITIMER pin internal pullup resistance		13.8	35	$\text{k}\Omega$
V_{INT}	ITIMER pin internal pullup voltage	2.1	2.57	2.74	V
$V_{ITIMER(F)}$	ITIMER comparator threshold, $I_{OUT} > I_{LIM}$	0.609	1.05	1.37	V
ΔV_{ITIMER}	ITIMER discharge differential voltage threshold, $I_{OUT} > I_{LIM}$	1.286	1.52	1.741	V
POWER GOOD INDICATION (PG) - TPS25972x/4x					
V_{PGD}	PG pin voltage while de-asserted. $V_{IN} < V_{UVP(F)}$, $V_{EN} < V_{SD(F)}$, Weak pull-up ($I_{PG} = 26\ \mu\text{A}$)		663	1000	mV
	PG pin voltage while de-asserted. $V_{IN} < V_{UVP(F)}$, $V_{EN} < V_{SD(F)}$, Strong pull-up ($I_{PG} = 242\ \mu\text{A}$)		782	1000	mV
	PG pin voltage while de-asserted, $V_{IN} > V_{UVP(R)}$		0	600	mV
I_{PGLKG}	PG pin leakage current, PG asserted			3	μA
POWERGOOD THRESHOLD (PGTH)					
$V_{PGTH(R)}$	PGTH rising threshold	1.178	1.2	1.23	V
$V_{PGTH(F)}$	PGTH falling threshold	1.071	1.1	1.13	V
$I_{PGTHLKG}$	PGTH pin leakage current	-1		1	μA
FAULT INDICATION (FLT) - TPS25970x					
I_{FLTLKG}	$\overline{\text{FLT}}$ pin leakage current	-1		1	μA
R_{FLT}	$\overline{\text{FLT}}$ pin internal pull-down resistance		12.4		Ω
OVERTEMPERATURE PROTECTION (OTP)					
TSD	Thermal Shutdown rising threshold, $T_J \uparrow$		154		$^{\circ}\text{C}$
TSD _{HYS}	Thermal Shutdown hysteresis, $T_J \downarrow$		10		$^{\circ}\text{C}$
DVDT					
I_{dVdt}	dVdt pin internal charging current	1.4	3.4	5.7	μA

7.6 Timing Requirements

PARAMETER		TEST CONDITIONS			MIN	TYP	MAX	UNIT
t_{OVLO}	Overvoltage lockout response time	TPS25970x and TPS25974x, $V_{OVLO} > V_{OV(R)}$ to $V_{OUT \downarrow}$				1.2		μs
t_{OVC}	Overvoltage clamp response time	TPS25972x, $V_{IN} > V_{OVC}$ to $V_{OUT \downarrow}$				5		μs
t_{CB}	Circuit-Breaker response time	TPS25974x, $I_{OUT} > I_{LIM} + 30\%$ to $V_{OUT \downarrow}$				2		μs
t_{LIM}	Current limit response time	TPS25970x and TPS25972x, $I_{OUT} > I_{LIM} + 30\%$ to I_{OUT} settling to within 5% of I_{LIM}				465		μs
t_{SC}	Short-circuit response time	$I_{OUT} > 3 \times I_{LIM}$ to output current cut off				550		ns
t_{FT}	Fixed fast-trip response time	$I_{OUT} > I_{FT}$ to $I_{OUT \downarrow}$				550		ns
$t_{TSD,RST}$	Thermal Shutdown auto-retry Interval	Device enabled and $T_J < \text{TSD} - \text{TSD}_{HYS}$				110		ms
t_{PGA}	PG assertion de-glitch time	$V_{PGTH} > V_{PGTH(R)}$ to $\text{PG} \uparrow$				14		μs
t_{PGD}	PG de-assertion de-glitch time	$V_{PGTH} < V_{PGTH(F)}$ to $\text{PG} \downarrow$				14		μs

7.7 Switching Characteristics

The output rising slew rate is internally controlled and constant across the entire operating voltage range to ensure the turn on timing is not affected by the load conditions. The rising slew rate can be adjusted by adding capacitance from the dVdt pin to ground. As C_{dVdt} is increased it will slow the rising slew rate (SR). See Slew Rate and Inrush Current Control (dVdt) section for more details. The Turn-Off Delay and Fall Time, however, are dependent on the RC time constant of the load capacitance (C_{OUT}) and Load Resistance (R_L). The Switching Characteristics are only valid for the power-up sequence where the supply is available in steady state condition and the load voltage is completely discharged before the device is enabled. Typical values are taken at $T_J = 25^\circ\text{C}$ unless specifically noted otherwise. $R_L = 100\ \Omega$, $C_{OUT} = 1\ \mu\text{F}$.

PARAMETER		V_{IN}	$C_{dVdt} = \text{Open}$	$C_{dVdt} = 1800\ \text{pF}$	$C_{dVdt} = 3300\ \text{pF}$	UNITS
SR_{ON}	Output rising slew rate	2.7 V	8.922	1.218	0.72	V/ms
		12 V	21.45	1.562	0.901	
		23 V	34.16	1.761	1.003	
$t_{D,ON}$	Turn-on delay	2.7 V	0.138	0.505	0.79	ms
		12 V	0.145	0.979	1.659	
		23 V	0.15	1.478	2.562	
t_R	Rise time	2.7 V	0.242	1.771	2.993	ms
		12 V	0.446	6.131	10.63	
		23 V	0.538	10.43	18.31	
t_{ON}	Turn-on time	2.7 V	0.379	2.277	3.783	ms
		12 V	0.582	7.11	12.29	
		23 V	0.668	11.91	20.87	
$t_{D,OFF}$	Turn-off delay	2.7 V	22.1	22.1	22.1	μs
		12 V	18.9	18.9	18.9	
		23 V	16.5	16.5	16.5	

7.8 Typical Characteristics

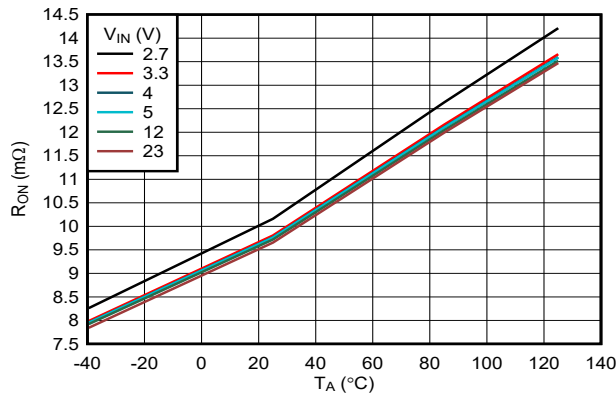

Figure 7-1. ON-Resistance vs Supply Voltage

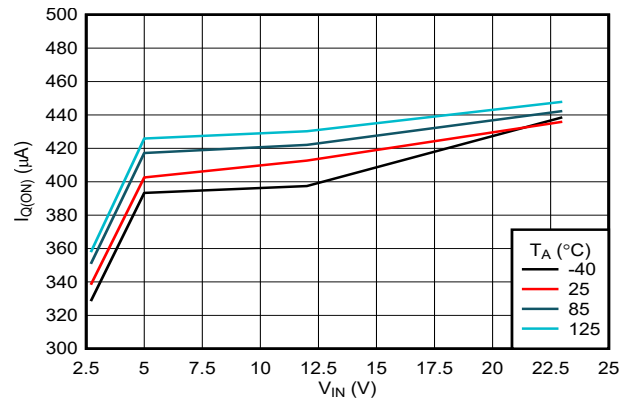

Figure 7-2. IN Quiescent Current vs Temperature (TPS25970x, TPS25974x Variants)

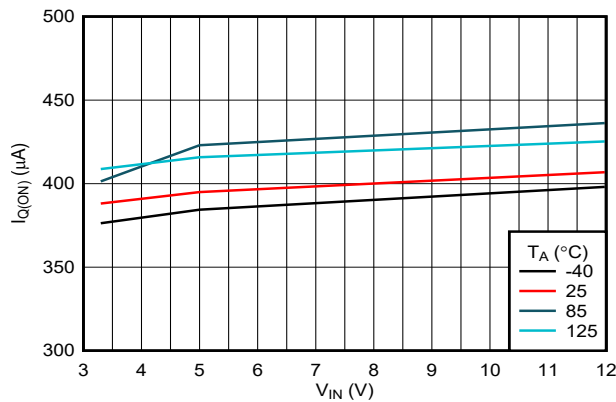

Figure 7-3. IN Quiescent Current vs Temperature (TPS25972x Variant)

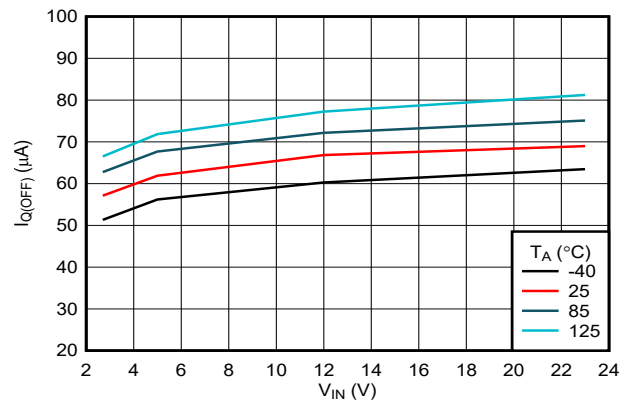

Figure 7-4. IN OFF State (UVLO) Current vs Temperature

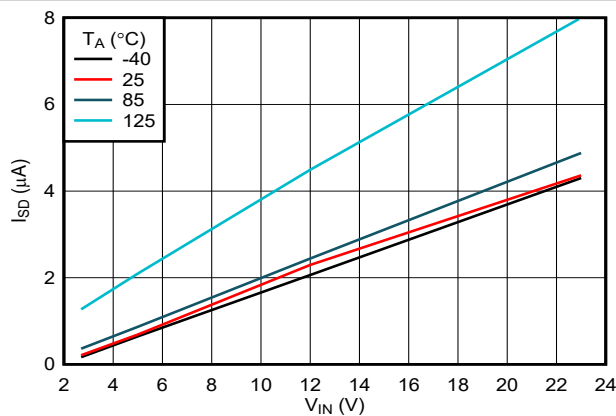

Figure 7-5. IN Shutdown Current vs Temperature

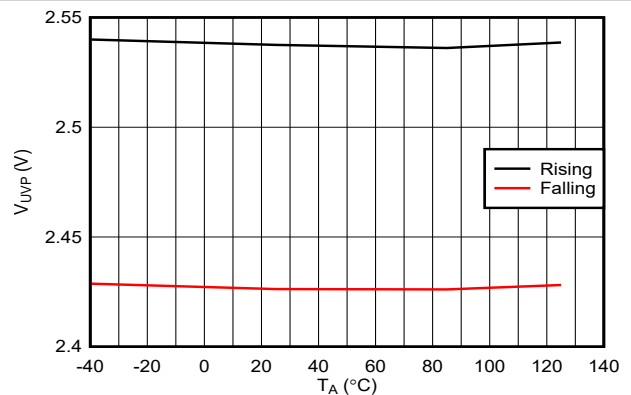

Figure 7-6. IN Undervoltage Threshold vs Temperature

7.8 Typical Characteristics (continued)

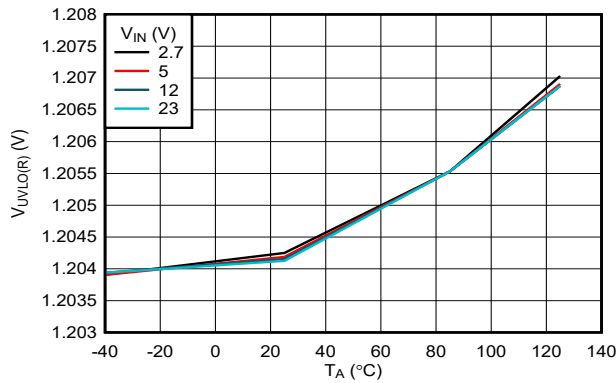

Figure 7-7. EN/UVLO Rising Threshold vs Temperature

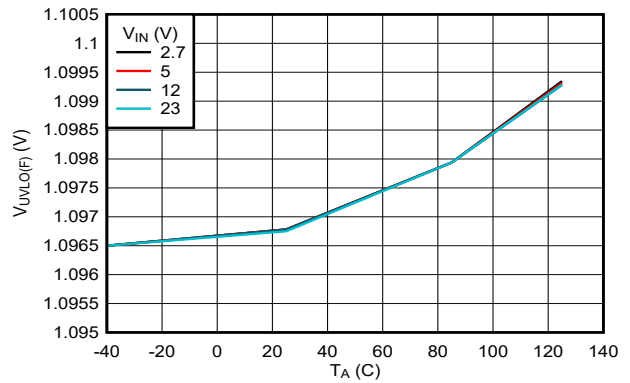

Figure 7-8. EN/UVLO Falling Threshold vs Temperature

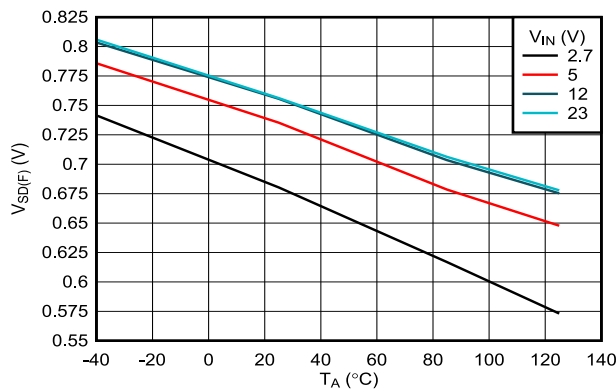

Figure 7-9. EN/UVLO Shutdown Falling Threshold vs Temperature

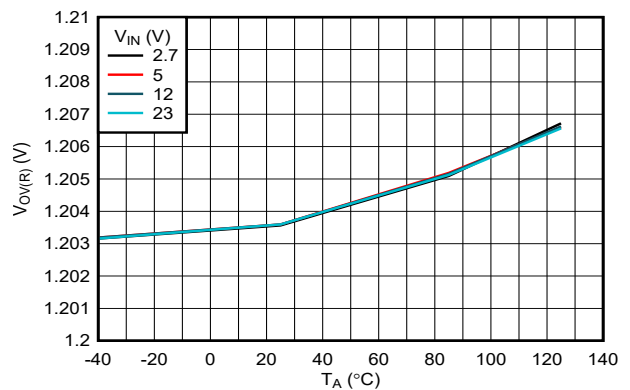

Figure 7-10. OVLO Rising Threshold vs Temperature (TPS25970x, TPS25974x Variants)

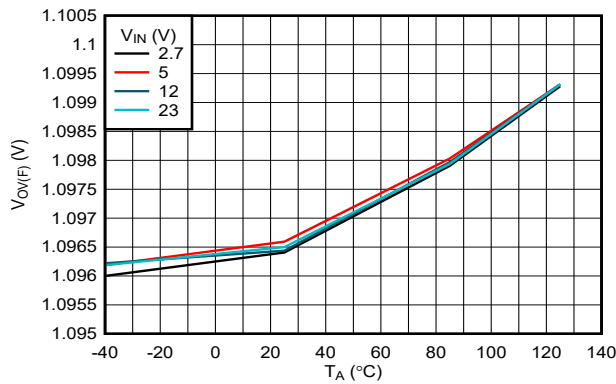

Figure 7-11. OVLO Falling Threshold vs Temperature (TPS25970x, TPS25974x Variants)

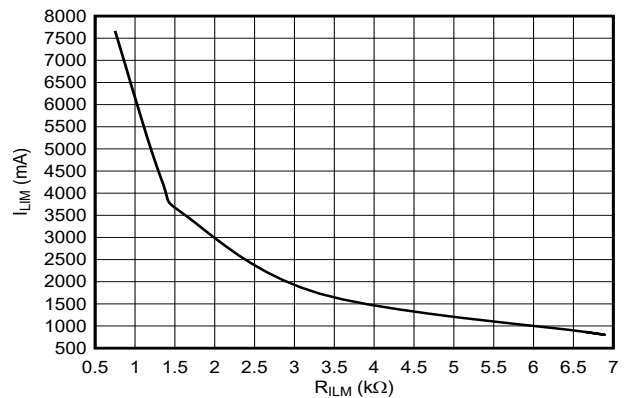

Figure 7-12. Overcurrent Threshold vs ILM Resistor

7.8 Typical Characteristics (continued)

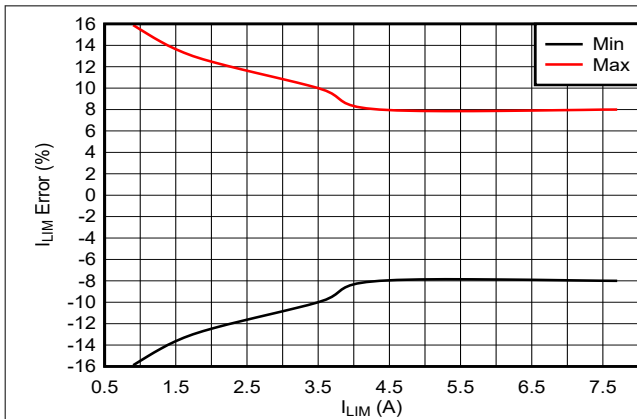

Figure 7-13. Overcurrent Threshold Accuracy (Across Process, Voltage and Temperature)

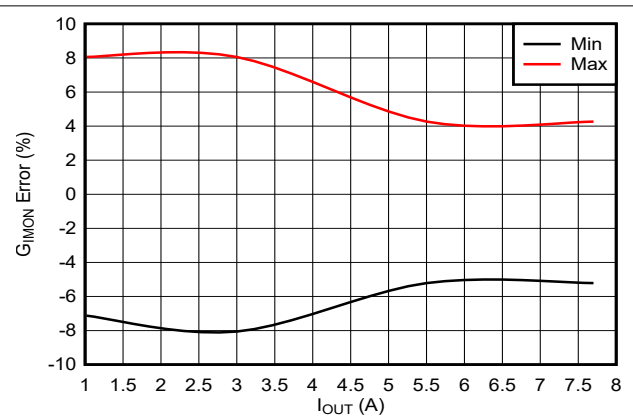

Figure 7-14. Analog Current Monitor Gain Accuracy

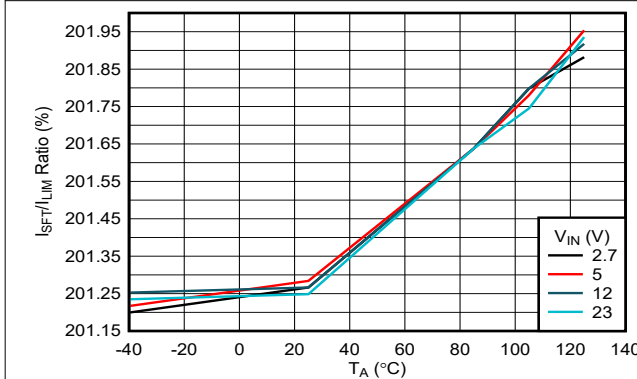

Figure 7-15. Scalable Fast-Trip Threshold: Current Limit Threshold (I_{LIM}) Ratio vs Temperature

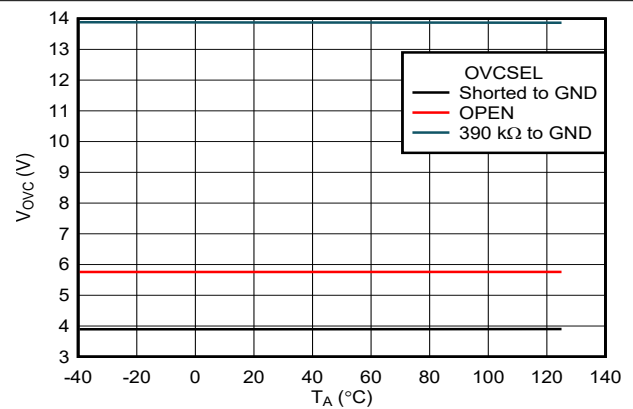

Figure 7-16. OVC Threshold vs Temperature (TPS25972x Variant)

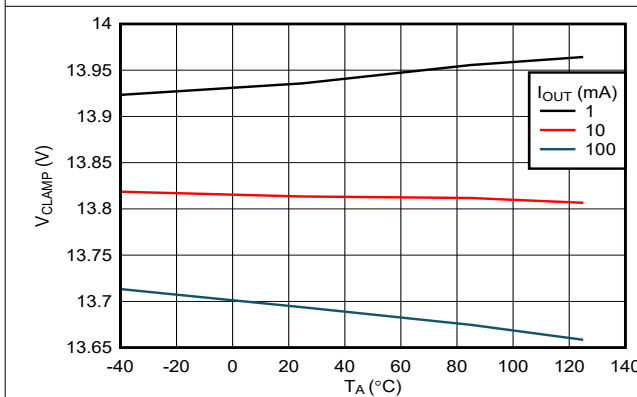

Figure 7-17. OVC Clamping Voltage (OVCSEL = 390 kΩ to GND) vs Load Current (TPS25972x Variant)

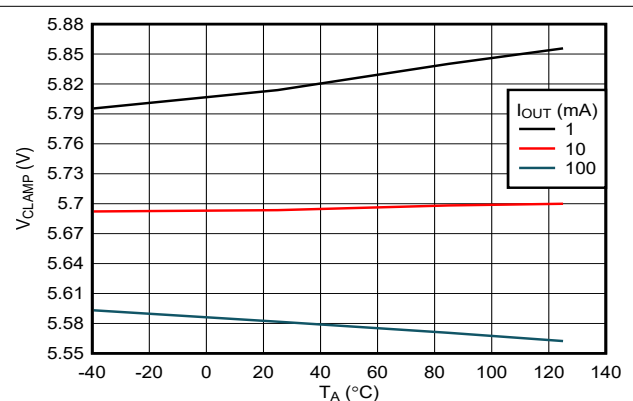

Figure 7-18. OVC Clamping Voltage (OVCSEL = OPEN) vs Load Current (TPS25972x Variant)

7.8 Typical Characteristics (continued)

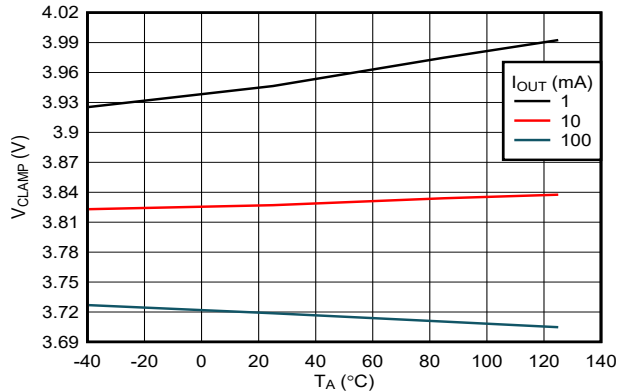

Figure 7-19. OVC Clamping Voltage (OVSEL = GND) vs Load Current (TPS2597x Variant)

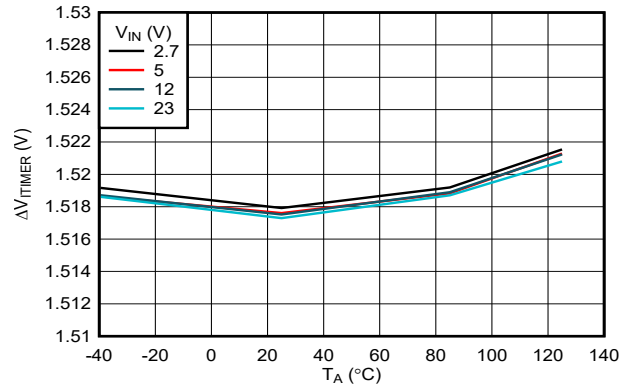

Figure 7-20. ITIMER Discharge Differential Voltage Threshold vs Temperature

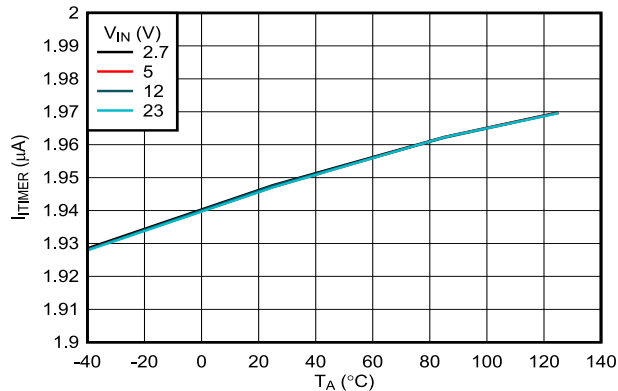

Figure 7-21. ITIMER Discharge Current vs Temperature

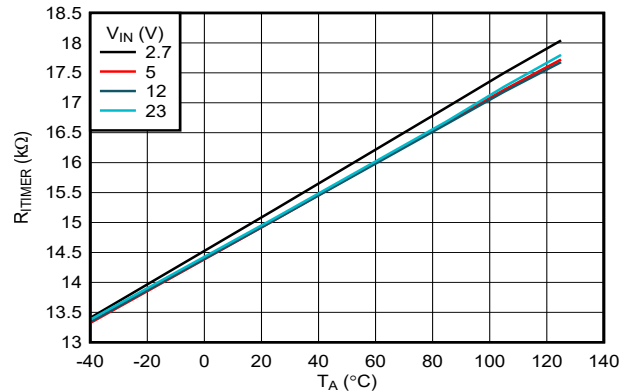

Figure 7-22. ITIMER Internal Pullup Resistance vs Temperature

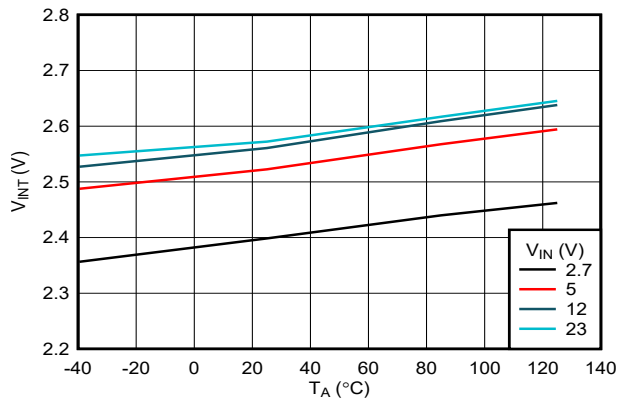

Figure 7-23. ITIMER internal Pullup Voltage vs Temperature

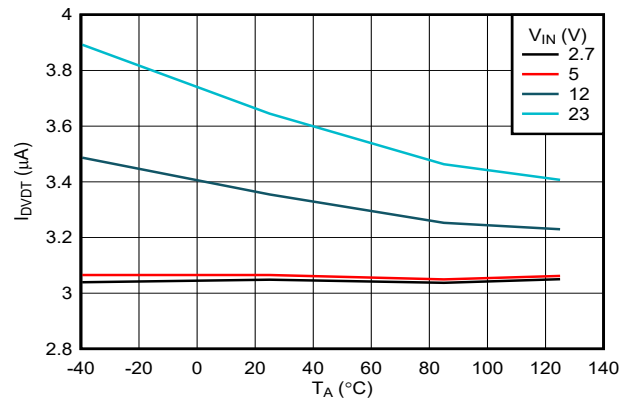

Figure 7-24. DVDT Charging Current vs Temperature

7.8 Typical Characteristics (continued)

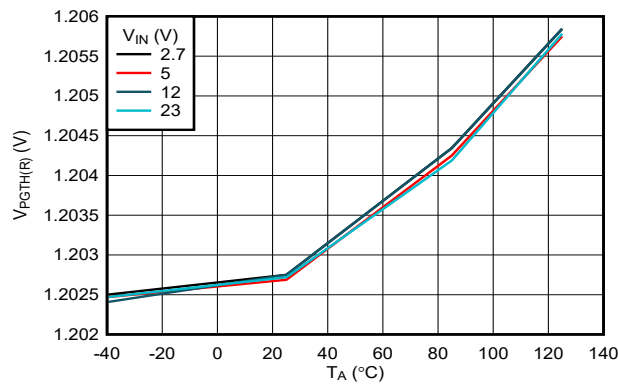

Figure 7-25. PGTH Threshold (Rising) vs Temperature (TPS25972x, TPS25974x Variants)

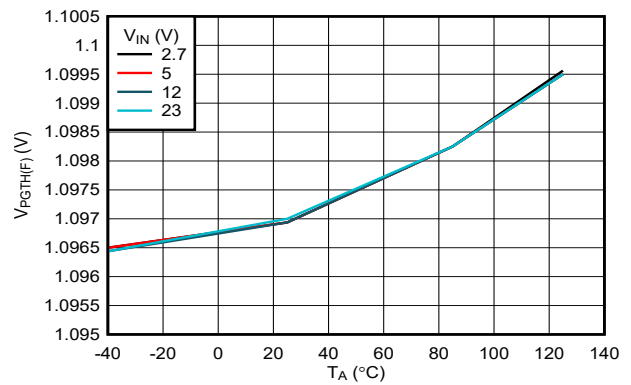

Figure 7-26. PGTH Threshold (Falling) vs Temperature (TPS25972x, TPS25974x Variants)

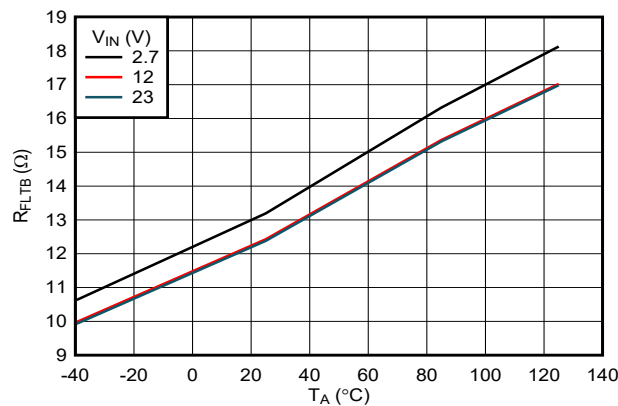

Figure 7-27. FLT Pin Pulldown Resistance vs Temperature

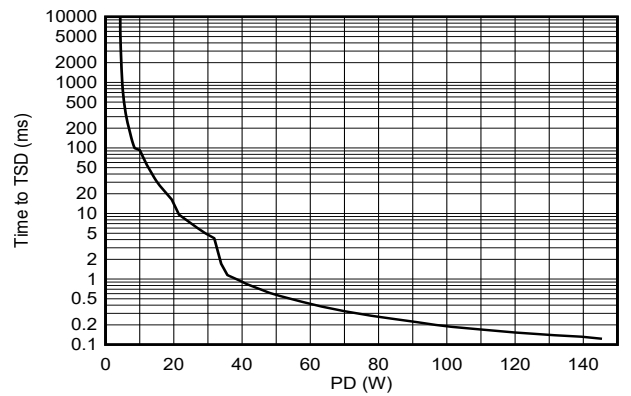

Figure 7-28. Time to Thermal Shut-Down During Inrush State

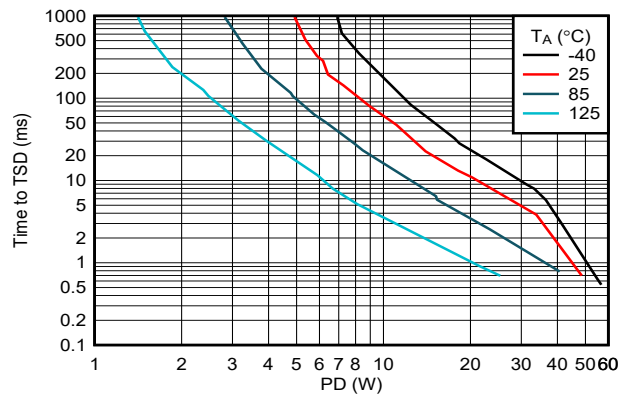
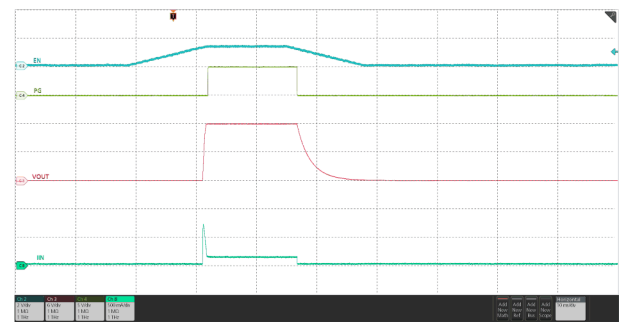

Figure 7-29. Time to Thermal Shut-Down During Steady State



$V_{IN} = 12\text{ V}$, $C_{OUT} = 22\ \mu\text{F}$, $C_{dVdt} = \text{Open}$, $V_{EN/UVLO}$ ramped from $0\text{ V} \rightarrow 1.4\text{ V} \rightarrow 0\text{ V}$

Figure 7-30. Power Up and Down With EN/UVLO Control

7.8 Typical Characteristics (continued)

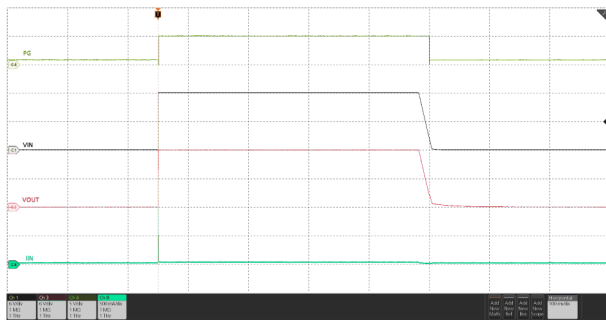

$V_{EN/UVLO} = 2\text{ V}$, $C_{OUT} = 22\ \mu\text{F}$, $C_{dVdt} = \text{Open}$, V_{IN} ramped from $0\text{ V} \rightarrow 12\text{ V} \rightarrow 0\text{ V}$

Figure 7-31. Power Up and Down With Input Supply

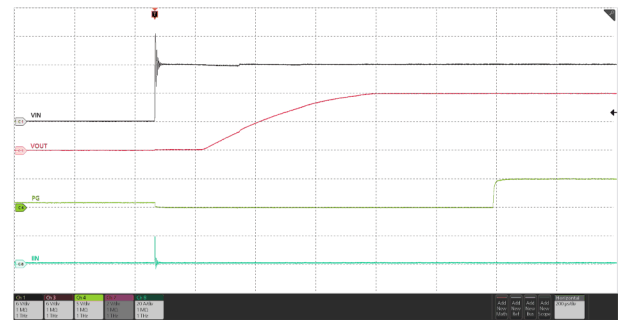

$C_{OUT} = 22\ \mu\text{F}$, $C_{dVdt} = \text{Open}$, EN/UVLO connected to IN through resistor ladder, 12 V hot-plugged to IN

Figure 7-32. Input Hot-Plug

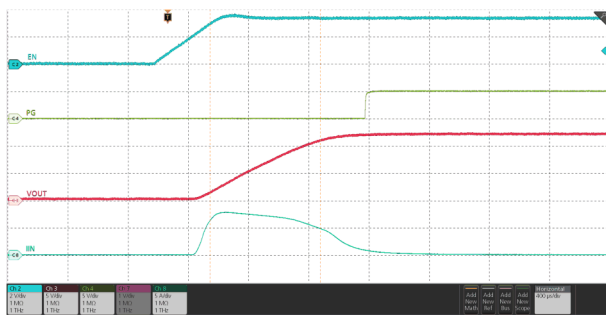

$V_{IN} = 12\text{ V}$, $C_{OUT} = 470\ \mu\text{F}$, $C_{dVdt} = \text{Open}$, $V_{EN/UVLO}$ stepped up to 3.3 V

Figure 7-33. Inrush Current Without Slew Rate Control – Capacitive Load

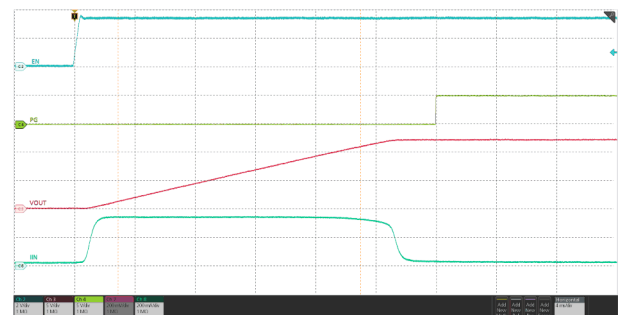

$V_{IN} = 12\text{ V}$, $C_{OUT} = 470\ \mu\text{F}$, $C_{dVdt} = 5100\ \text{pF}$, $V_{EN/UVLO}$ stepped up to 3.3 V

Figure 7-34. Inrush Current With Slew Rate Control – Capacitive Load

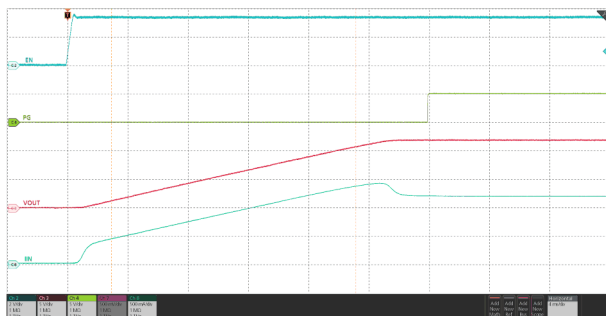

$V_{IN} = 12\text{ V}$, $C_{OUT} = 470\ \mu\text{F}$, $R_{OUT} = 10\ \Omega$, $C_{dVdt} = 5100\ \text{pF}$, $V_{EN/UVLO}$ stepped up to 3.3 V

Figure 7-35. Inrush Current With Slew Rate Control – Resistive and Capacitive Load

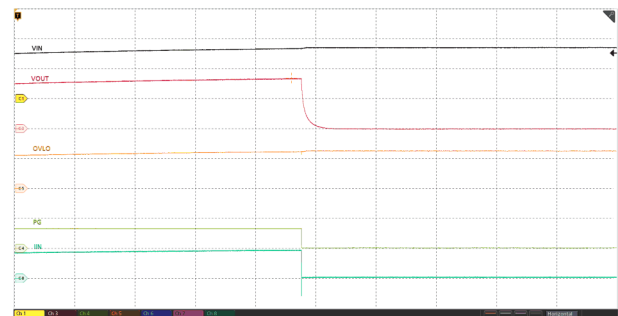

OV threshold set to 16.7 V, V_{IN} ramped up from 12 V to 17 V

Figure 7-36. Overvoltage Lockout Response – TPS25970x and TPS25974x

7.8 Typical Characteristics (continued)

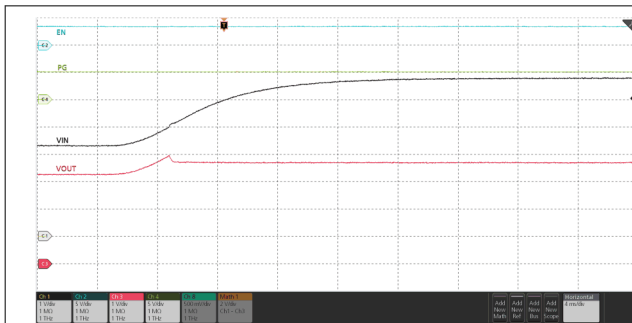

$R_{OVSEL} = GND$, $C_{OUT} = 220 \mu F$, $I_{OUT} = 200 \text{ mA}$, V_{IN} ramped up from 3.3 V to 5.8 V

Figure 7-37. Overvoltage Clamp Response – TPS25972x

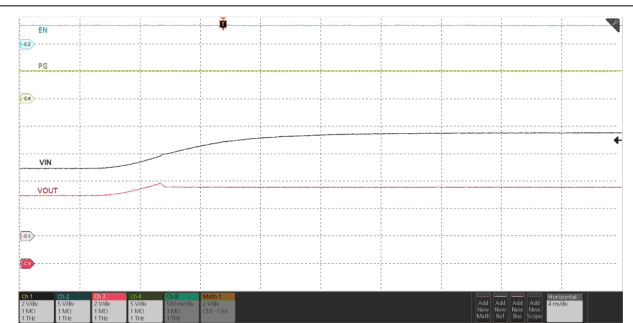

$R_{OVSEL} = \text{Open}$, $C_{OUT} = 220 \mu F$, $I_{OUT} = 200 \text{ mA}$, V_{IN} ramped up from 5 V to 7.5 V

Figure 7-38. Overvoltage Clamp Response – TPS25972x

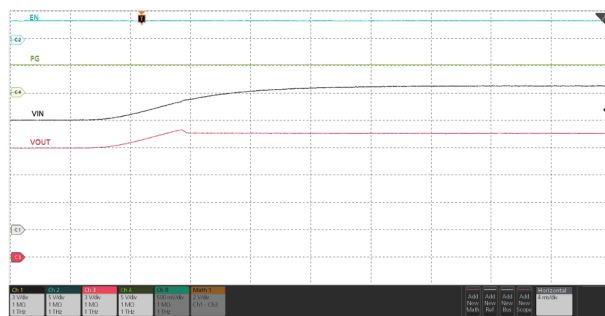

$R_{OVSEL} = 390 \text{ k}\Omega$, $C_{OUT} = 220 \mu F$, $I_{OUT} = 200 \text{ mA}$, V_{IN} ramped up from 12 V to 16.5 V

Figure 7-39. Overvoltage Clamp Response – TPS25972x

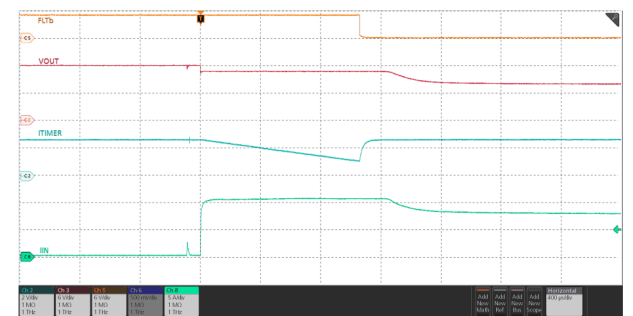

$V_{IN} = 12 \text{ V}$, $C_{TIMER} = 1.3 \text{ nF}$, $C_{OUT} = 220 \mu F$, $R_{ILM} = 715 \Omega$, I_{OUT} stepped from 0 A \rightarrow 11 A

Figure 7-40. Active Current Limit Response – TPS25970x

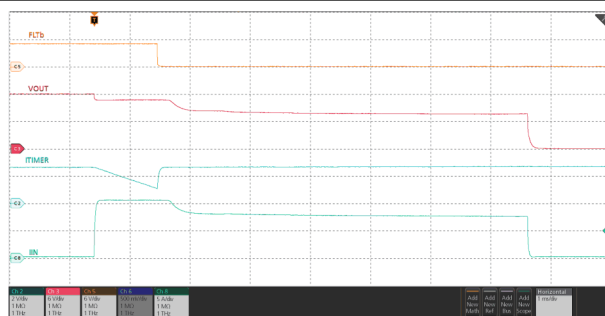

$V_{IN} = 12 \text{ V}$, $C_{TIMER} = 1.3 \text{ nF}$, $C_{OUT} = 220 \mu F$, $R_{ILM} = 715 \Omega$, I_{OUT} stepped from 0 A \rightarrow 11 A

Figure 7-41. Active Current Limit Response Followed by TSD – TPS25970x

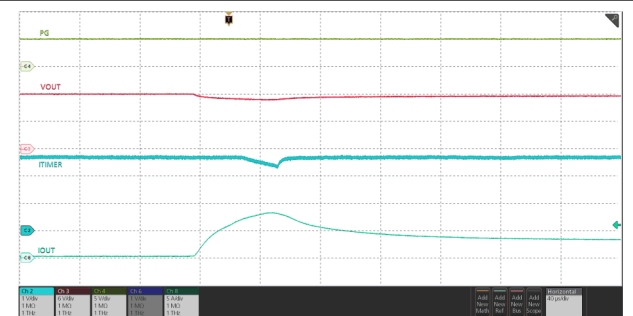

$V_{IN} = 12 \text{ V}$, $C_{TIMER} = 120 \text{ pF}$, $C_{OUT} = 470 \mu F$, $R_{ILM} = 715 \Omega$, I_{OUT} ramped from 0 A \rightarrow 8 A \rightarrow 4 A within 100 μs

Figure 7-42. Transient Overcurrent Blanking Timer Response

7.8 Typical Characteristics (continued)

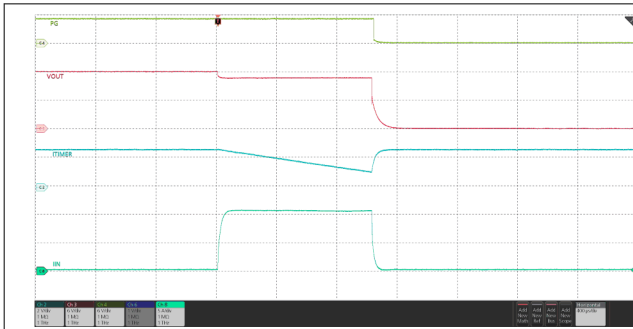

$V_{IN} = 12\text{ V}$, $C_{ITIMER} = 1.3\text{ nF}$, $C_{OUT} = 470\text{ }\mu\text{F}$, $R_{ILM} = 715\text{ }\Omega$,
 I_{OUT} stepped from $0\text{ A} \rightarrow 11\text{ A}$

Figure 7-43. Circuit-Breaker Response TPS25974x

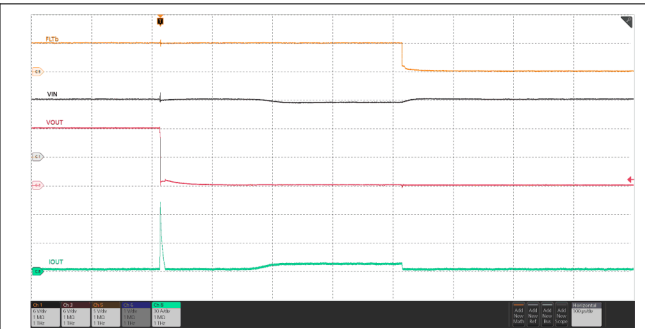

$V_{IN} = 12\text{ V}$, $R_{ILM} = 715\text{ }\Omega$, OUT stepped from Open \rightarrow Short-circuit to GND

Figure 7-44. Output Short-Circuit During Steady State

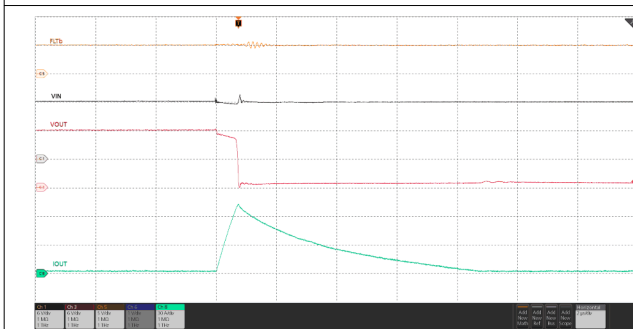

$V_{IN} = 12\text{ V}$, $R_{ILM} = 715\text{ }\Omega$, OUT stepped from Open \rightarrow Short-circuit to GND

Figure 7-45. Output Short-Circuit During Steady State (Zoomed In)

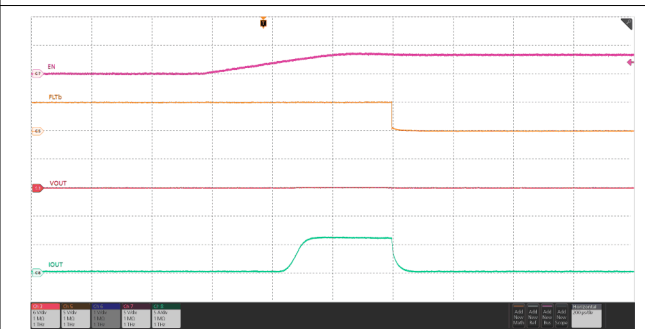

$V_{IN} = 12\text{ V}$, $C_{OUT} = \text{Open}$, OUT short-circuit to GND, $R_{ILM} = 715\text{ }\Omega$, $V_{EN/UVLO}$ stepped from 0 V to 3.3 V

Figure 7-46. Power Up into Short-Circuit

8 Detailed Description

8.1 Overview

The TPS2597xx is an eFuse with an integrated power path that is used to ensure safe power delivery in a system. The device starts its operation by monitoring the IN bus. When the input supply voltage (V_{IN}) exceeds the undervoltage protection threshold (V_{UVP}), the device samples the EN/UVLO pin. A high level ($> V_{UVLO}$) on this pin enables the internal power path (HFET) to start conducting and allow current to flow from IN to OUT. When EN/UVLO is held low ($< V_{UVLO}$), the internal power path is turned off.

After a successful start-up sequence, the device now actively monitors its load current and input voltage, and controls the internal HFET to ensure that the user adjustable overcurrent limit threshold (I_{LIM}) is not exceeded and overvoltage spikes are either safely clamped to the selected threshold voltage (V_{OVC}) or cut-off after they cross the user-adjustable overvoltage lockout threshold (V_{OVLO}). The device also provides fast protection against severe overcurrent during short-circuit events. This feature keeps the system safe from harmful levels of voltage and current. At the same time, a user-adjustable overcurrent blanking timer allows the system to pass moderate transient peaks in the load current profile without tripping the eFuse. This action ensures a robust protection solution against real faults which is also immune to transients, thereby ensuring maximum system uptime.

The device also has a built-in thermal sensor based shutdown mechanism to protect itself in case the device temperature (T_J) exceeds the recommended operating conditions.

8.2 Functional Block Diagram

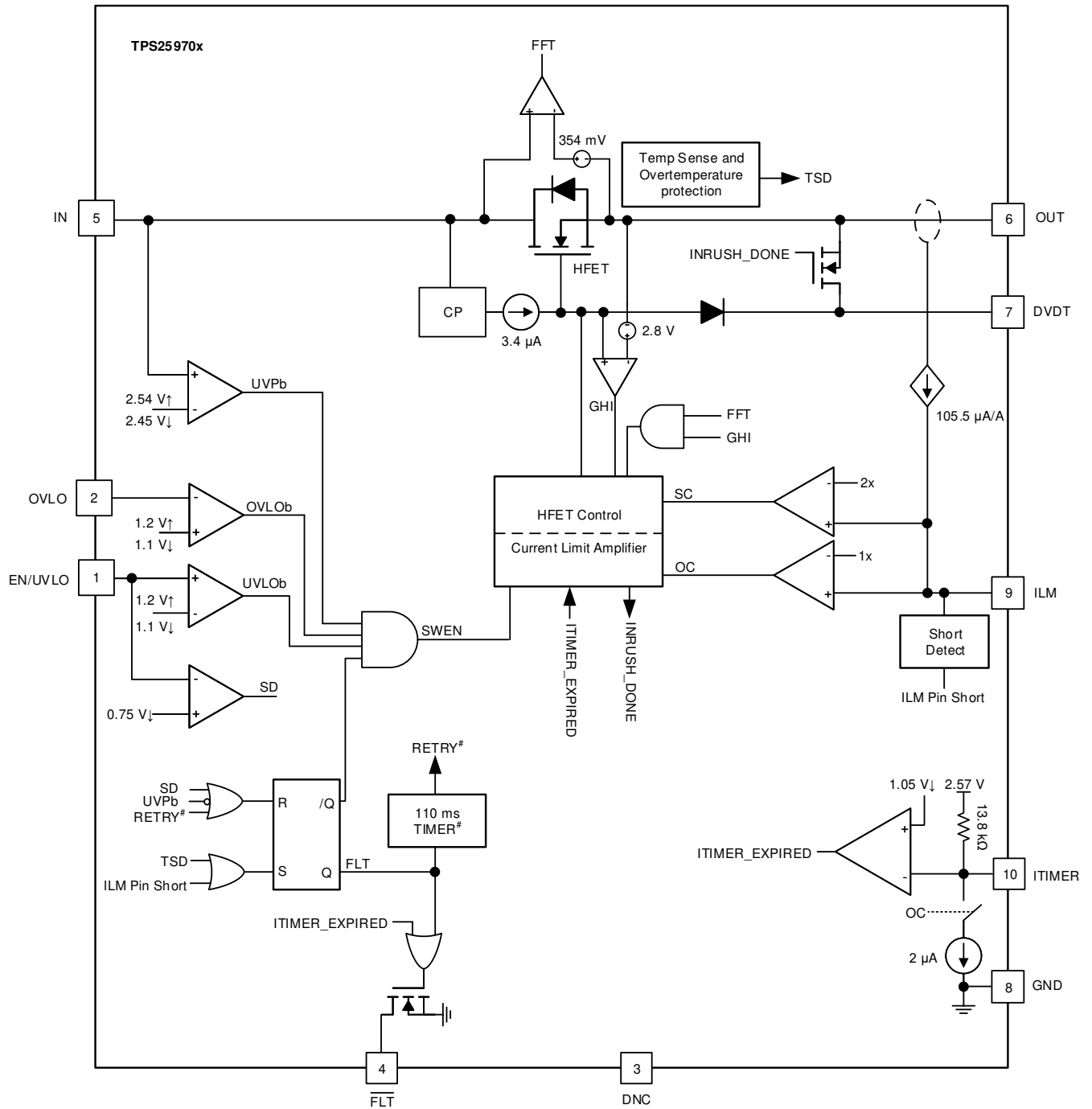

Not applicable to Latch-off variants (TPS25970L)

Figure 8-1. TPS25970x Block Diagram

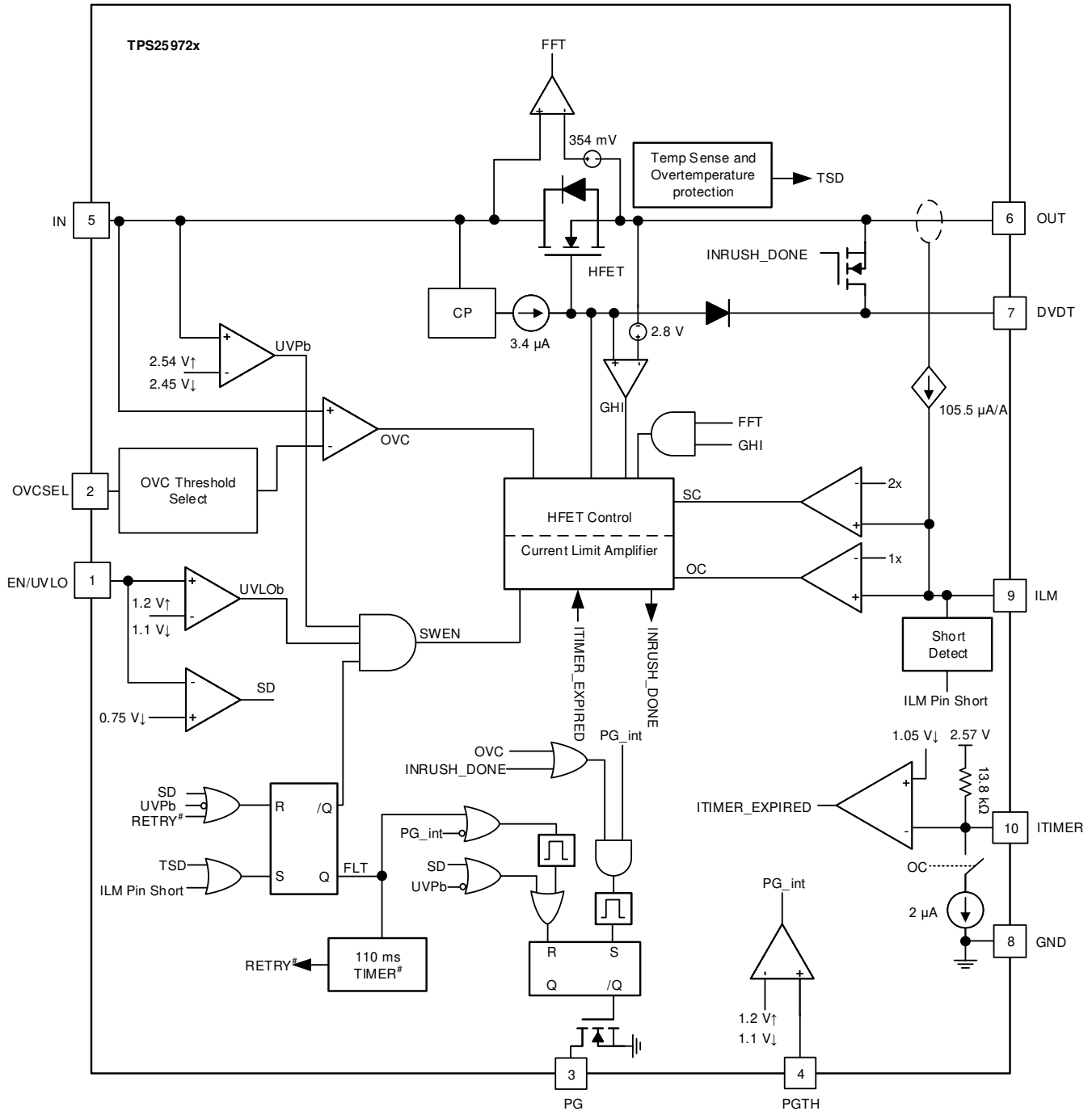

Not applicable to Latch-off variants (TPS25972L)

Figure 8-2. TPS25972x Block Diagram

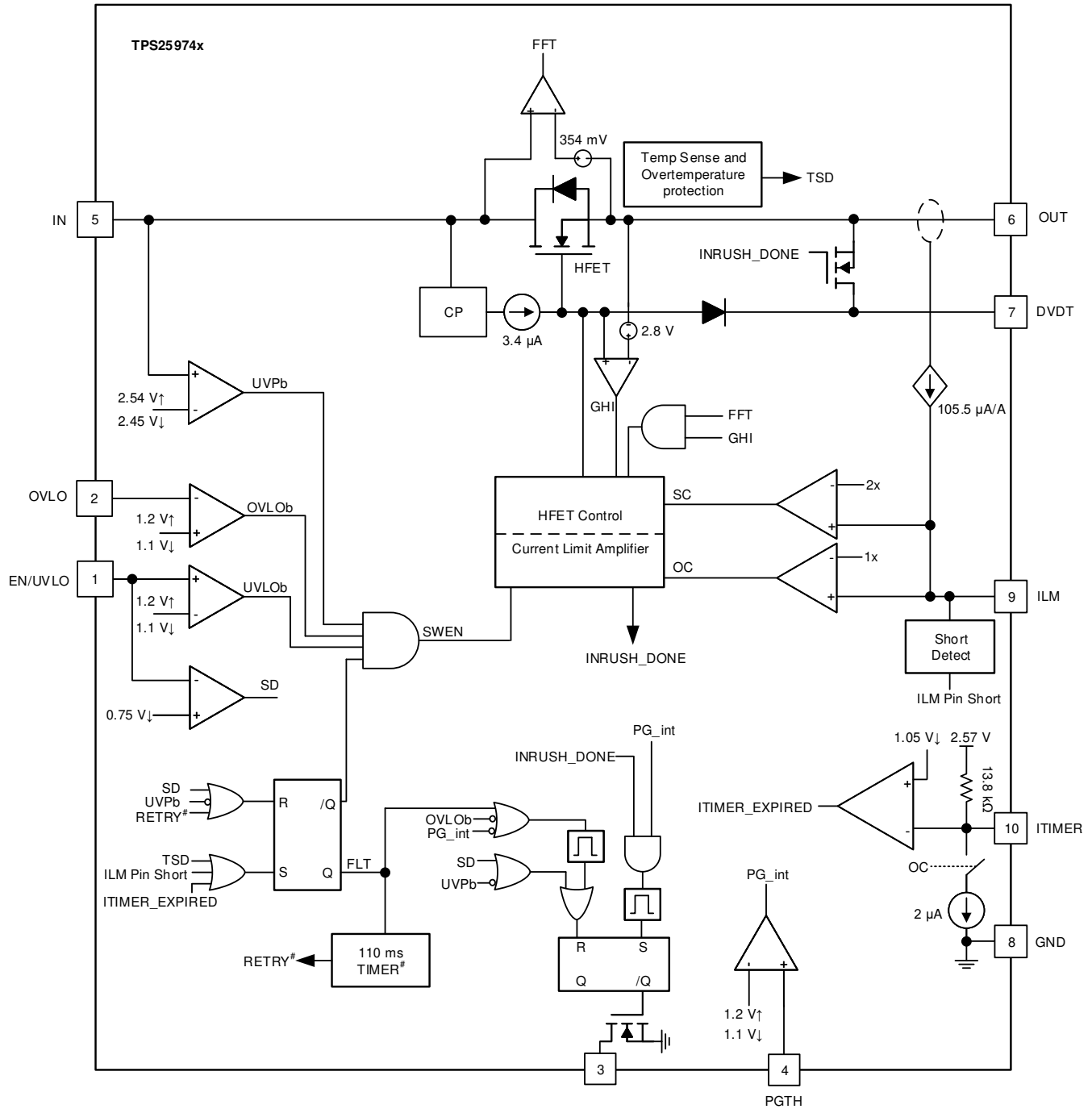

Not applicable to Latch-off variants (TPS25974L)

Figure 8-3. TPS25974x Block Diagram

8.3 Feature Description

The TPS2597xx eFuse is a compact, feature-rich power management device that provides detection, protection, and indication in the event of system faults.

8.3.1 Undervoltage Lockout (UVLO and UVP)

The TPS2597xx implements undervoltage protection on IN in case the applied voltage becomes too low for the system or device to properly operate. The undervoltage protection has a default lockout threshold of V_{UVLP} which is fixed internally. Also, the UVLO comparator on the EN/UVLO pin allows the undervoltage protection threshold to be externally adjusted to a user-defined value. Figure 8-4 and Equation 1 show how a resistor divider can be used to set the UVLO set point for a given voltage supply.

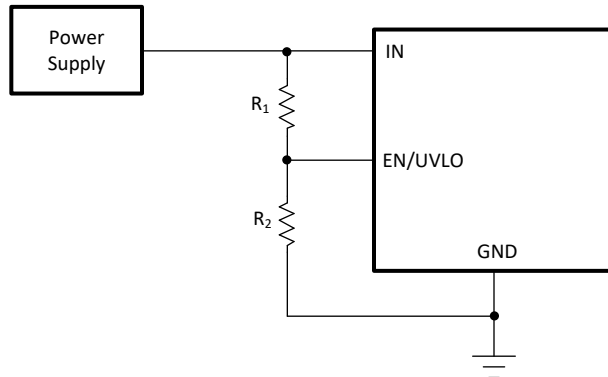

Figure 8-4. Adjustable Undervoltage Protection

$$V_{IN(UV)} = \frac{V_{UVLO} \times (R_1 + R_2)}{R_2} \quad (1)$$

8.3.2 Overvoltage Lockout (OVLO)

The TPS25970x and TPS25974x variants allow the user to implement overvoltage lockout to protect the load from input overvoltage conditions. The OVLO comparator on the OVLO pin allows the overvoltage protection threshold to be adjusted to a user-defined value. After the voltage at the OVLO pin crosses the OVLO rising threshold, $V_{OV(R)}$, the device turns off the power to the output. Thereafter, the devices wait for the voltage at the OVLO pin to fall below the OVLO falling threshold, $V_{OV(F)}$ before the output power is turned ON again. The rising and falling thresholds are slightly different to provide hysteresis. Figure 8-5 and Equation 2 show how a resistor divider can be used to set the OVLO set point for a given voltage supply.

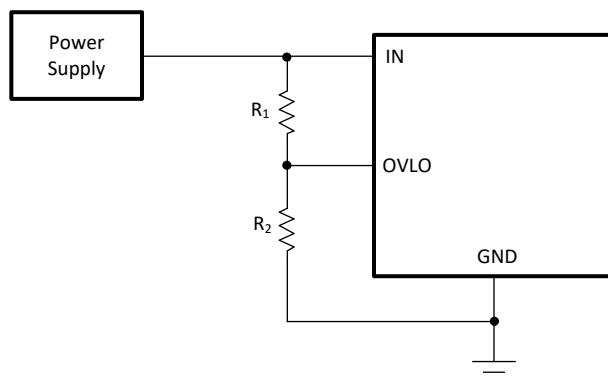

Figure 8-5. Adjustable Overvoltage Protection

$$V_{IN(OV)} = \frac{V_{OV} \times (R_1 + R_2)}{R_2} \quad (2)$$

While recovering from a OVLO event, the TPS25970x variants start up with inrush control (dVdt).

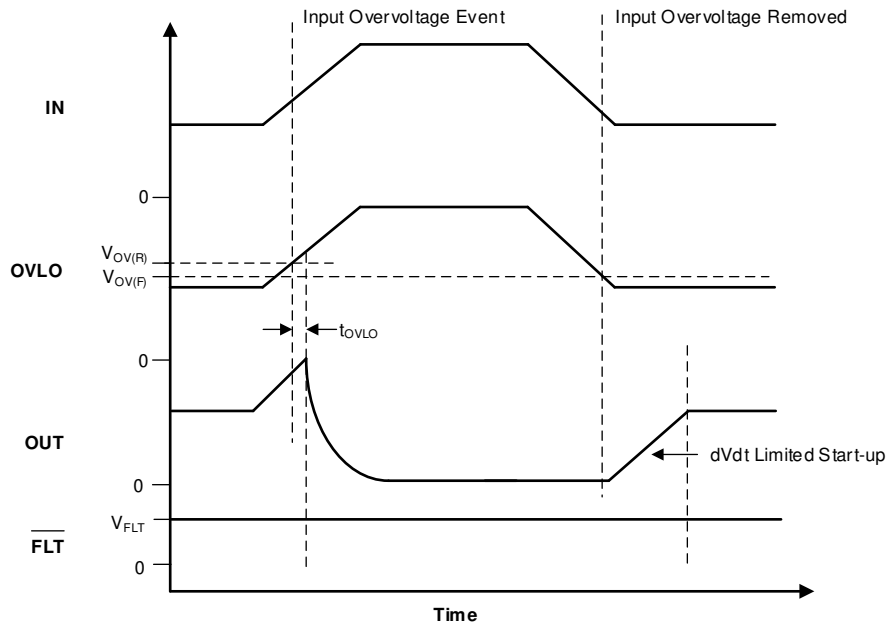

Figure 8-6. TPS25970x Overvoltage Lockout and Recovery

While recovering from an OVLO event, the TPS25974x variants start up with inrush control (dVdt).

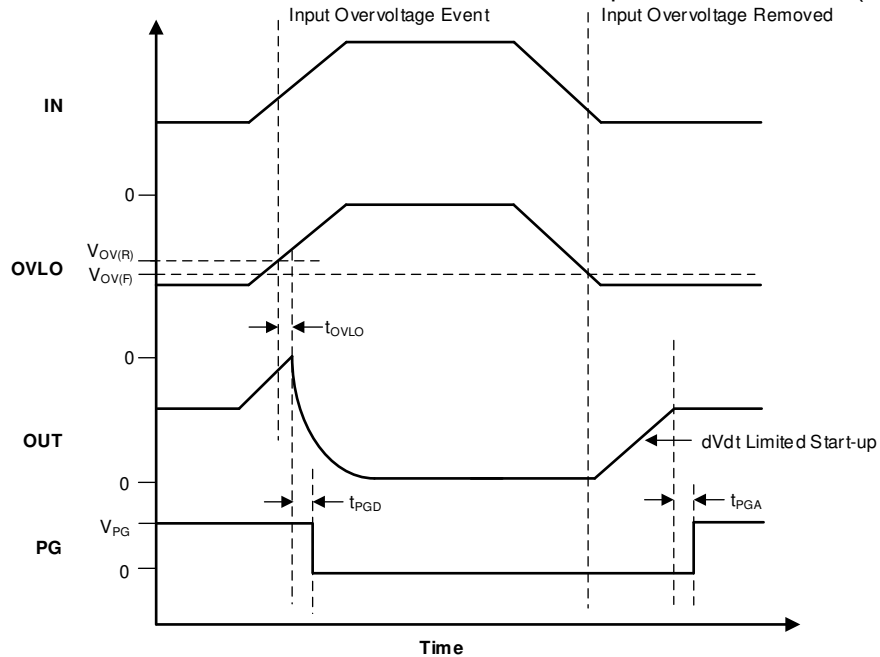

Figure 8-7. TPS25974x Overvoltage Lockout and Recovery

8.3.3 Overvoltage Clamp (OVC)

The TPS25972x variants implement a voltage clamp on the output to protect the system in the event of input overvoltage. When the device detects the input has exceeded the overvoltage clamp threshold (V_{OVC}), it quickly responds within t_{OVC} and stops the output from rising further. The device then regulates the HFET linearly to clamp the output voltage below V_{CLAMP} as long as an overvoltage condition is present on the input.

If the part stays in clamping state for an extended period of time, there is higher power dissipation inside the part which can eventually lead to thermal shutdown (TSD). After the part shuts down due to TSD fault, it either

stays latched off (TPS25972L variant) or restart automatically after a fixed delay (TPS25972A variant). See [Overtemperature Protection \(OTP\)](#) for more details on device response to overtemperature.

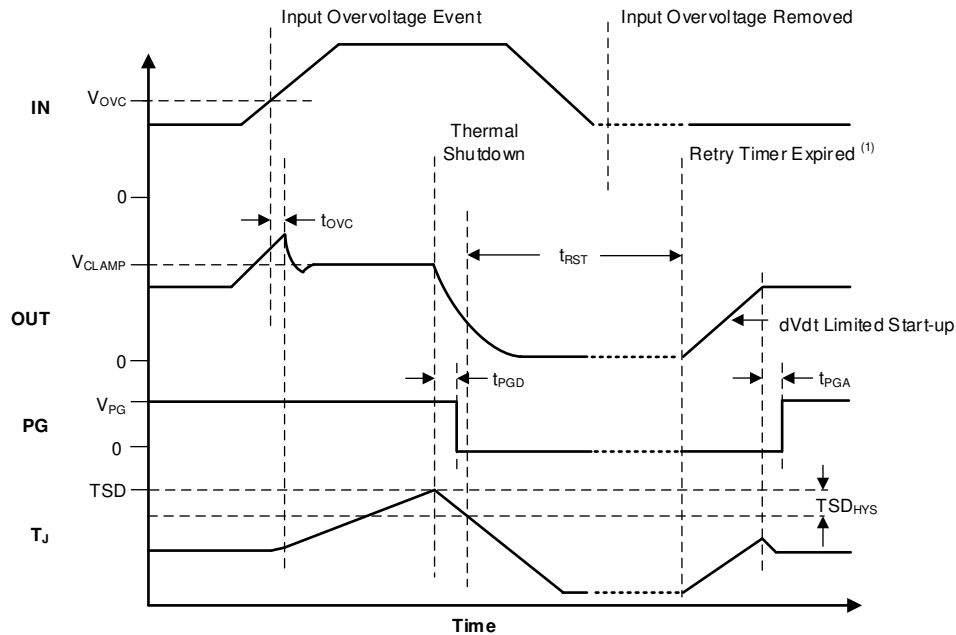

⁽¹⁾ Applicable only for TPS25972A (Auto-retry variant)

Figure 8-8. TPS2597x Overvoltage Response (Auto-Retry)

There are three available overvoltage clamp threshold options, which can be configured using the OVCSEL pin.

Table 8-1. TPS2597x Overvoltage Clamp Threshold Selection

OVCSEL PIN CONNECTION	OVERVOLTAGE CLAMP THRESHOLD
Shorted to GND	3.89 V
Open	5.76 V
Connected to GND through a 390-kΩ resistor	13.88 V

8.3.4 Inrush Current, Overcurrent, and Short Circuit Protection

TPS2597xx incorporates four levels of protection against overcurrent:

1. Adjustable slew rate (dVdt) for inrush current control
2. Adjustable threshold (I_{LIM}) for overcurrent protection during start-up or steady-state
3. Adjustable threshold (I_{SC}) for fast-trip response to severe overcurrent during start-up or steady-state
4. Fixed threshold (I_{FT}) for fast-trip response to quickly protect against hard output short-circuits during steady-state

8.3.4.1 Slew Rate (dVdt) and Inrush Current Control

During hot-plug events or while trying to charge a large output capacitance at start-up, there can be a large inrush current. If the inrush current is not managed properly, it can damage the input connectors or cause the system power supply to droop leading to unexpected restarts elsewhere in the system or both. The inrush current during turn on is directly proportional to the load capacitance and rising slew rate. Use [Equation 3](#) to find the slew rate (SR) required to limit the inrush current (I_{INRUSH}) for a given load capacitance (C_{OUT}):

$$SR (V/ms) = \frac{I_{INRUSH} (mA)}{C_{OUT} (\mu F)} \quad (3)$$

A capacitor can be connected to the dVdt pin to control the rising slew rate and lower the inrush current during turn on. Use [Equation 4](#) to calculate the required C_{dVdt} capacitance to produce a given slew rate.

$$C_{dVdt} \text{ (pF)} = \frac{3300}{SR \text{ (V/ms)}} \quad (4)$$

The fastest output slew rate is achieved by leaving the dVdt pin open.

Note

For $C_{dVdt} > 10 \text{ nF}$, TI recommends to add a 100-Ω resistor in series with the capacitor on the dVdt pin.

8.3.4.2 Circuit-Breaker

The circuit-breaker variants (TPS25974x) respond to output overcurrent conditions by turning off the output after a user-adjustable transient fault blanking interval. When the load current exceeds the set overcurrent threshold (I_{LIM}) set by the ILM pin resistor (R_{ILM}), but stays lower than the fast-trip threshold ($2 \times I_{LIM}$), the device starts discharging the ITIMER pin capacitor using an internal 2-μA pulldown current. If the load current drops below I_{LIM} before the ITIMER pin capacitor (C_{ITIMER}) discharges by ΔV_{ITIMER} , the ITIMER is reset by pulling it up to V_{INT} internally and the circuit breaker action is not engaged. This action allows short load transient pulses to pass through the device without tripping the circuit. If the overcurrent condition persists, the C_{ITIMER} continues to discharge and after it discharges by ΔV_{ITIMER} , the circuit breaker action turns off the HFET immediately. At the same time, the C_{ITIMER} is charged up to V_{INT} again so that it is at its default state before the next overcurrent event. This action ensures the full blanking timer interval is provided for every overcurrent event. Use [Equation 5](#) to calculate the R_{ILM} value for an overcurrent threshold.

$$R_{ILM} \text{ (}\Omega\text{)} = \frac{5747}{I_{LIM} \text{ (A)}} \quad (5)$$

Note

1. Leaving the ILM pin Open sets the current limit to nearly zero and results in the part breaking the circuit with the slightest amount of loading at the output.
 2. Shorting the ILM pin to ground at any point during normal operation is detected as a fault and the part shuts down. There is a minimum current (I_{FLT}) which the part allows in this condition before the pin short condition is detected.
-

The duration for which transients are allowed can be adjusted using an appropriate capacitor value from ITIMER pin to ground. Use [Equation 6](#) to calculate the C_{ITIMER} value needed to set the desired transient overcurrent blanking interval.

$$t_{ITIMER} \text{ (ms)} = \frac{\Delta V_{ITIMER} \text{ (V)} \times C_{ITIMER} \text{ (nF)}}{I_{ITIMER} \text{ (}\mu\text{A)}} \quad (6)$$

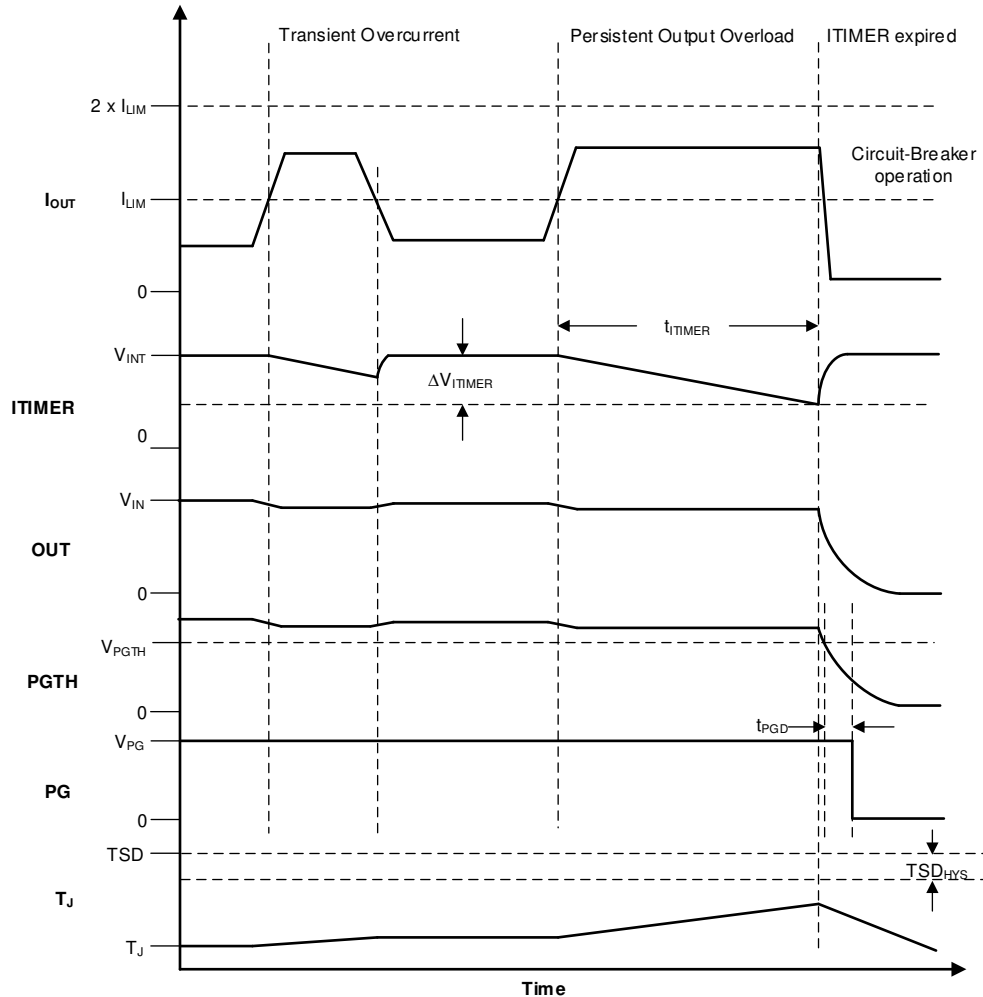

Figure 8-9. TPS25974x Overcurrent Response

Note

1. Leave the ITIMER pin open to allow the part to break the circuit with the minimum possible delay.
2. Shorting the ITIMER pin to ground results in minimum overcurrent response delay (similar to ITIMER pin open condition), but increases the device current consumption. This action is not a recommended mode of operation.
3. Increasing the ITIMER cap value extends the overcurrent blanking interval, but it also extends the time needed for the ITIMER cap to recharge up to V_{INT} . If the next overcurrent event occurs before the ITIMER cap is recharged fully, it takes less time to discharge to the ITIMER expiry threshold, thereby providing a shorter blanking interval than intended.

After the part shuts down due to a circuit-breaker fault, it either stays latched off (TPS25974L variant) or restart automatically after a fixed delay (TPS25974A variant).

8.3.4.3 Active Current Limiting

The active current limit variants (TPS25970x and TPS25972x) respond to output overcurrent conditions by actively limiting the current after a user adjustable transient fault blanking interval. When the load current exceeds the set overcurrent threshold (I_{LIM}) set by the ILM pin resistor (R_{ILM}), but stays lower than the short-circuit threshold ($2 \times I_{LIM}$), the device starts discharging the ITIMER pin capacitor using an internal 2- μ A pulldown current. If the load current drops below the overcurrent threshold before the ITIMER capacitor (C_{ITIMER}) discharges by ΔV_{ITIMER} , the ITIMER is reset by pulling it up to V_{INT} internally and the current limit action is not

engaged. This event allows short load transient pulses to pass through the device without getting current limited. If the overcurrent condition persists, the C_{ITIMER} continues to discharge and after it discharges by ΔV_{ITIMER} , the current limit starts regulating the HFET to actively limit the current to the set overcurrent threshold (I_{LIM}). At the same time, the C_{ITIMER} is charged up to V_{INT} again so that it is at its default state before the next overcurrent event. This event ensures the full blanking timer interval is provided for every overcurrent event. Use [Equation 7](#) to calculate the R_{ILM} value for a desired overcurrent threshold.

$$R_{ILM} (\Omega) = \frac{5747}{I_{LIM} (A)} \quad (7)$$

Note

1. Leaving the ILM pin open sets the current limit to nearly zero and results in the part entering current limit with the slightest amount of loading at the output.
 2. The current limit circuit employs a foldback mechanism. The current limit threshold in the foldback region ($0 V < V_{OUT} < V_{FB}$) is lower than the steady state current limit threshold (I_{LIM}).
 3. Shorting the ILM pin to ground at any point during normal operation is detected as a fault and the part shuts down. There's a minimum current (I_{FLT}) which the part allows in this condition before the pin short condition is detected.
-

The duration for which transients are allowed can be adjusted using an appropriate capacitor value from ITIMER pin to ground. Use [Equation 8](#) to calculate the C_{ITIMER} value needed to set the desired transient overcurrent blanking interval.

$$t_{ITIMER} (ms) = \frac{\Delta V_{ITIMER} (V) \times C_{ITIMER} (nF)}{I_{ITIMER} (\mu A)} \quad (8)$$

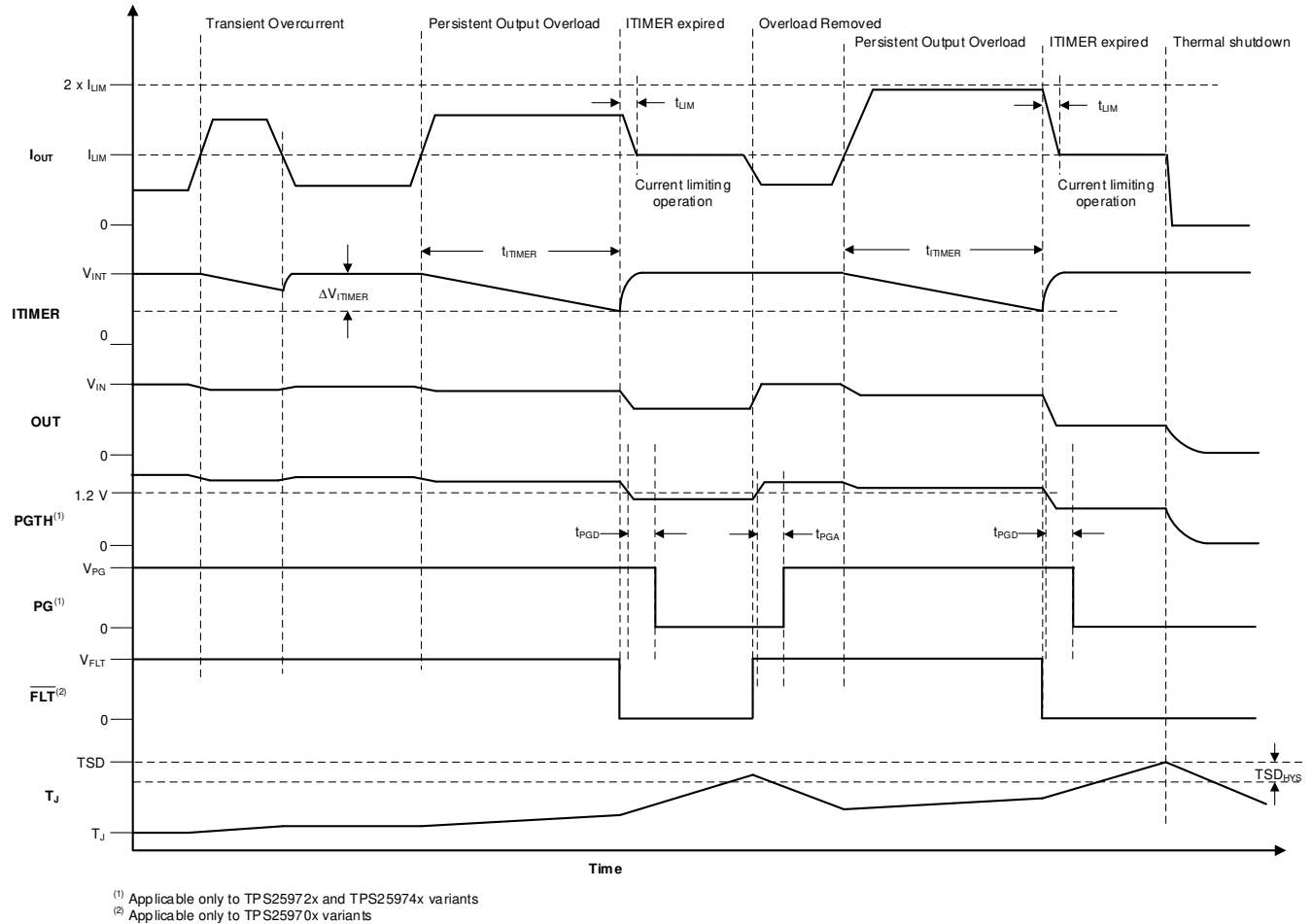
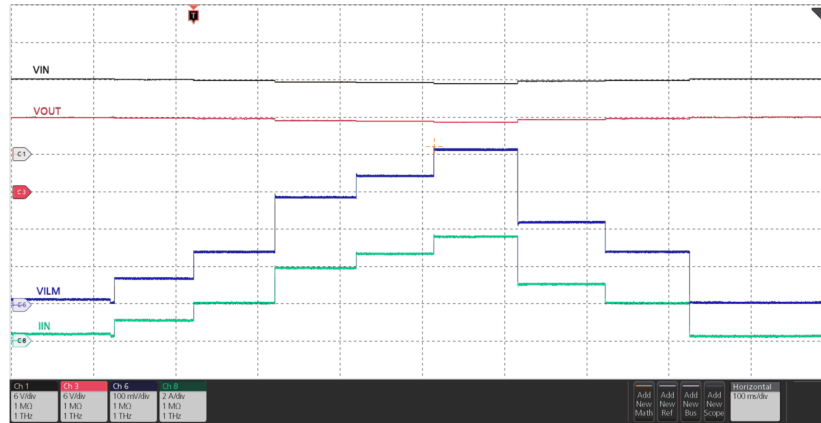

Figure 8-10. TPS25970x and TPS25972x Active Current Limit Response

Note

1. Leave the ITIMER pin open to allow the part to limit the current with the minimum possible delay.
2. Shorting the ITIMER pin to ground results in minimum overcurrent response delay (similar to ITIMER pin open condition), but increases the device current consumption. This action is not a recommended mode of operation.
3. Active current limiting based on R_{ILIM} is active during start-up for TPS25970x, TPS25972x (active current limit) as well as TPS25974x (circuit-breaker) variants. In case the start-up current exceeds I_{LIM} , the device regulates the current to the set limit. However, during start-up the current limit is engaged without waiting for the ITIMER delay.
4. For the TPS25972x variants, during overvoltage clamp condition, if an overcurrent event occurs, the current limit is engaged without waiting for the ITIMER delay.
5. Increasing the C_{ITIMER} value extends the overcurrent blanking interval, but it also extends the time needed for the C_{ITIMER} to recharge up to V_{INT} . If the next overcurrent event occurs before the C_{ITIMER} is recharged fully, it takes lesser time to discharge to the ITIMER expiry threshold, thereby providing a shorter blanking interval than intended.

During active current limit, the output voltage drops, resulting in increased device power dissipation across the HFET. If the device internal temperature (T_J) exceeds the thermal shutdown threshold (TSD), the HFET is turned off. After the part shuts down due to TSD fault, it either stays latched off (TPS2597xL variants) or restarts automatically after a fixed delay (TPS2597xA variants). See [Overtemperature Protection \(OTP\)](#) for more details on device response to overtemperature.



$V_{IN} = 12\text{ V}$, $R_{ILM} = 715\ \Omega$, I_{OUT} varied dynamically between 0 A and 5.5 A

Figure 8-12. Analog Load Current Monitor Response

Note

The ILM pin is sensitive to capacitive loading. Careful design and layout is needed to ensure the parasitic capacitive loading on the ILM pin is $< 50\text{ pF}$ for stable operation.

8.3.6 Overtemperature Protection (OTP)

The device monitors the internal die temperature (T_J) at all times and shuts down the part as soon as the temperature exceeds a safe operating level (TSD), thereby protecting the device from damage. The device does not turn back on until the junction cools down sufficiently, that is the die temperature falls below $(TSD - TSD_{HYS})$.

When the TPS2597xL (latch-off variant) detects thermal overload, it shuts down and remains latched-off until the device is power cycled or re-enabled. When the TPS2597xA (auto-retry variant) detects thermal overload, it remains off until it has cooled down by TSD_{HYS} . Thereafter, the device remains off for an additional delay of t_{RST} after which it automatically retries to turn on if it is still enabled.

Table 8-2. Thermal Shutdown

DEVICE	ENTER TSD	EXIT TSD
TPS2597xL (Latch-Off)	$T_J \geq TSD$	$T_J < TSD - TSD_{HYS}$ V_{IN} cycled to 0 V and then above $V_{UVP(R)}$ OR EN/UVLO toggled below $V_{SD(F)}$
TPS2597xA (Auto-Retry)	$T_J \geq TSD$	$T_J < TSD - TSD_{HYS}$ V_{IN} cycled to 0 V and then above $V_{UVP(R)}$ or EN/UVLO toggled below $V_{SD(F)}$ or t_{RST} timer expired

8.3.7 Fault Response and Indication (\overline{FLT})

Table 8-3 summarizes the device response to various fault conditions. Additionally, an active low external fault indication (\overline{FLT}) pin is available on the TPS25970x variants.

Table 8-3. Fault Summary

EVENT	PROTECTION RESPONSE	FAULT LATCHED INTERNALLY	\overline{FLT} PIN STATUS ⁽¹⁾	\overline{FLT} ASSERTION DELAY ⁽¹⁾
Overtemperature	Shutdown	Y	L	
Undervoltage (UVP or UVLO)	Shutdown	N	H	

Table 8-3. Fault Summary (continued)

EVENT	PROTECTION RESPONSE	FAULT LATCHED INTERNALLY	FLT PIN STATUS ⁽¹⁾	$\overline{\text{FLT}}$ ASSERTION DELAY ⁽¹⁾
Input Overvoltage	Shutdown ^{(1) (2)}	N	H	
	Voltage Clamp ⁽²⁾	N	N/A	
Transient Overcurrent ($I_{\text{LIM}} < I_{\text{OUT}} < 2 \times I_{\text{LIM}}$)	None	N	N	
Persistent Overcurrent	Circuit Breaker ⁽³⁾	Y	N/A	
Persistent Overcurrent	Current Limit ⁽⁴⁾	N	L	t_{TIMER}
Output Short-Circuit to GND	Circuit Breaker followed by Current Limit	N	H	
ILM Pin Open (During Steady State)	Shutdown	N	L	t_{TIMER}
ILM Pin Shorted to GND	Shutdown	Y	L	t_{TIMER}

- (1) Applicable to TPS25970x variants only.
- (2) Applicable to TPS25972x variants only.
- (3) Applicable to TPS25974x variants only.
- (4) Applicable to TPS25970x and TPS25972x variants only.

Faults which are latched internally can be cleared either by power cycling the part (pulling V_{IN} to 0 V) or by pulling the EN/UVLO pin voltage below V_{SD} . This action also releases the $\overline{\text{FLT}}$ pin for the TPS25970x variants and resets the t_{RST} timer for the TPS2597xA (auto-retry) variants.

During a latched fault, pulling the EN/UVLO just below the UVLO threshold has no impact on the device. This fact is true for both TPS2597xL (latch-off) and TPS2597xA (auto-retry) variants.

For TPS2597xA (auto-retry) variants, on expiry of the t_{RST} timer after a fault, the device restarts automatically and the $\overline{\text{FLT}}$ pin is de-asserted (TPS25970A variant).

8.3.8 Power-Good Indication (PG)

The TPS25972x and TPS25974x variants provide an active high digital output (PG) which serves as a power-good indication signal and is asserted high depending on the voltage at the PGTH pin along with the device state information. The PG is an open-drain pin and must be pulled up to an external supply.

After power up, PG is pulled low initially. The device initiates a inrush sequence in which the HFET is turned on in a controlled manner. When the HFET gate voltage reaches the full overdrive indicating that the inrush sequence is complete and the voltage at PGTH is above $V_{\text{PGTH(R)}}$, the PG is asserted after a de-glitch time (t_{PGA}).

PG is de-asserted if at any time during normal operation, the voltage at PGTH falls below $V_{\text{PGTH(F)}}$, or the device detects a fault (except overcurrent). The PG de-assertion de-glitch time is t_{PGD} .

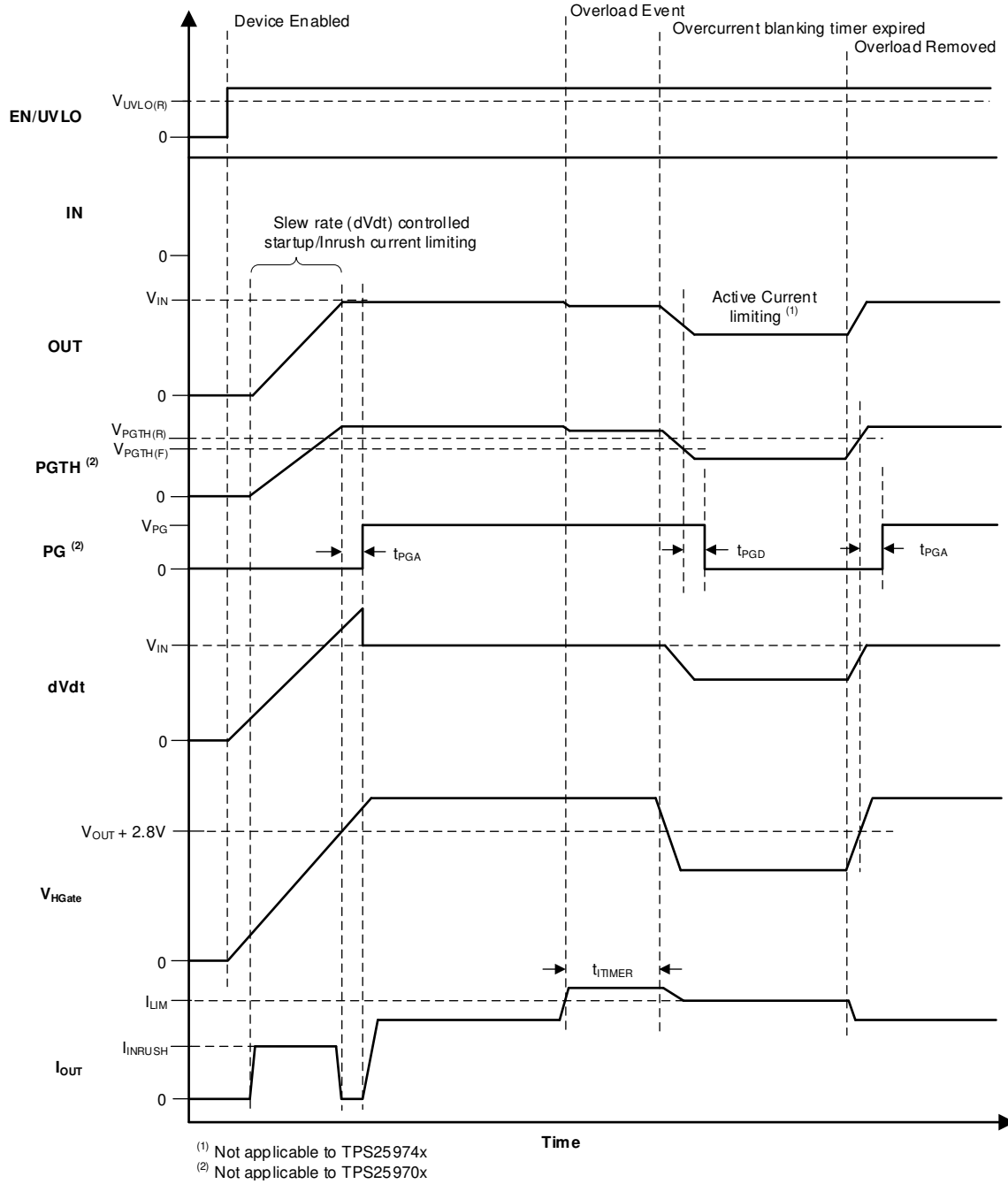

Figure 8-13. TPS25972x, TPS25974x PG Timing Diagram

Table 8-4. TPS25972x and TPS25974x PG Indication Summary

EVENT	DEVICE STATUS	PG PIN STATUS	PG PIN TOGGLE DELAY
Undervoltage (UVP or UVLO)	OFF	L	
Oversvoltage (TPS25972x only)	ON (Clamping)	H (If PGTH pin voltage > $V_{PGTH(R)}$) L (If PGTH pin voltage < $V_{PGTH(F)}$)	t_{PGA} t_{PGD}
Oversvoltage (TPS25974x only)	OFF	L	t_{PGD}
Steady state	ON	H (If PGTH pin voltage > $V_{PGTH(R)}$) L (If PGTH pin voltage < $V_{PGTH(F)}$)	t_{PGA} t_{PGD}
Transient overcurrent	ON	H (If PGTH pin voltage > $V_{PGTH(R)}$) L (If PGTH pin voltage < $V_{PGTH(F)}$)	t_{PGA} t_{PGD}
Persistent overload (TPS25972x only)	ON (Current Limiting)	H (If PGTH pin voltage > $V_{PGTH(R)}$) L (If PGTH pin voltage < $V_{PGTH(F)}$)	t_{PGA} t_{PGD}
Persistent overload (TPS25974x only)	OFF (Circuit-Breaker)	L	t_{PGD}
Output short-circuit to GND	Fast-trip followed by Current Limit	H (If PGTH pin voltage > $V_{PGTH(R)}$) L (If PGTH pin voltage < $V_{PGTH(F)}$)	t_{PGA} t_{PGD}
ILM pin open	OFF	L (If PGTH < 1.1 V)	$t_{PGD} + t_{TIMER}$
ILM pin shorted to GND	OFF	L	t_{PGD}
Overtemperature	OFF	L	t_{PGD}

When there is no supply to the device, the PG pin is expected to stay low. However, there is no active pulldown in this condition to drive this pin all the way down to 0 V. If the PG pin is pulled up to an independent supply which is present even if the device is unpowered, there can be a small voltage seen on this pin depending on the pin sink current, which is a function of the pullup supply voltage and resistor. Minimize the sink current to keep this pin voltage low enough not to be detected as a logic HIGH by associated external circuits in this condition.

8.4 Device Functional Modes

The TPS25970x and TPS25974x variants have only one functional mode that applies when operated within the recommended operating conditions.

The TPS25972x variants have three different functional modes depending on the OVCSEL pin connection.

Table 8-5. TPS25972x Oversvoltage Clamp Threshold Selection

OVCSEL PIN CONNECTION	OVERVOLTAGE CLAMP THRESHOLD
Shorted to GND	3.89 V
Open	5.76 V
Connected to GND through a 390-kΩ resistor	13.88 V

9 Application and Implementation

Note

Information in the following applications sections is not part of the TI component specification, and TI does not warrant its accuracy or completeness. TI's customers are responsible for determining suitability of components for their purposes, as well as validating and testing their design implementation to confirm system functionality.

9.1 Application Information

The TPS2597xx is a 2.7-V to 23-V, 7-A eFuse that is typically used for power rail protection applications. The device operates from 2.7 V to 23 V with adjustable overvoltage and undervoltage protection. The device provides ability to control inrush current and protection against overcurrent conditions. The device can be used in a variety of systems such as adapter input protection, server, PC motherboard, add-on cards, enterprise storage – RAID/HBA/SAN/eSSD, retail point-of-sale terminals, smartphones, and tablets. The design procedure explained in the subsequent sections can be used to select the supporting component values based on the application requirement. Additionally, a spreadsheet design tool, [TPS2597xx Design Calculator](#), is available in the web product folder.

9.1.1 Single Device, Self-Controlled

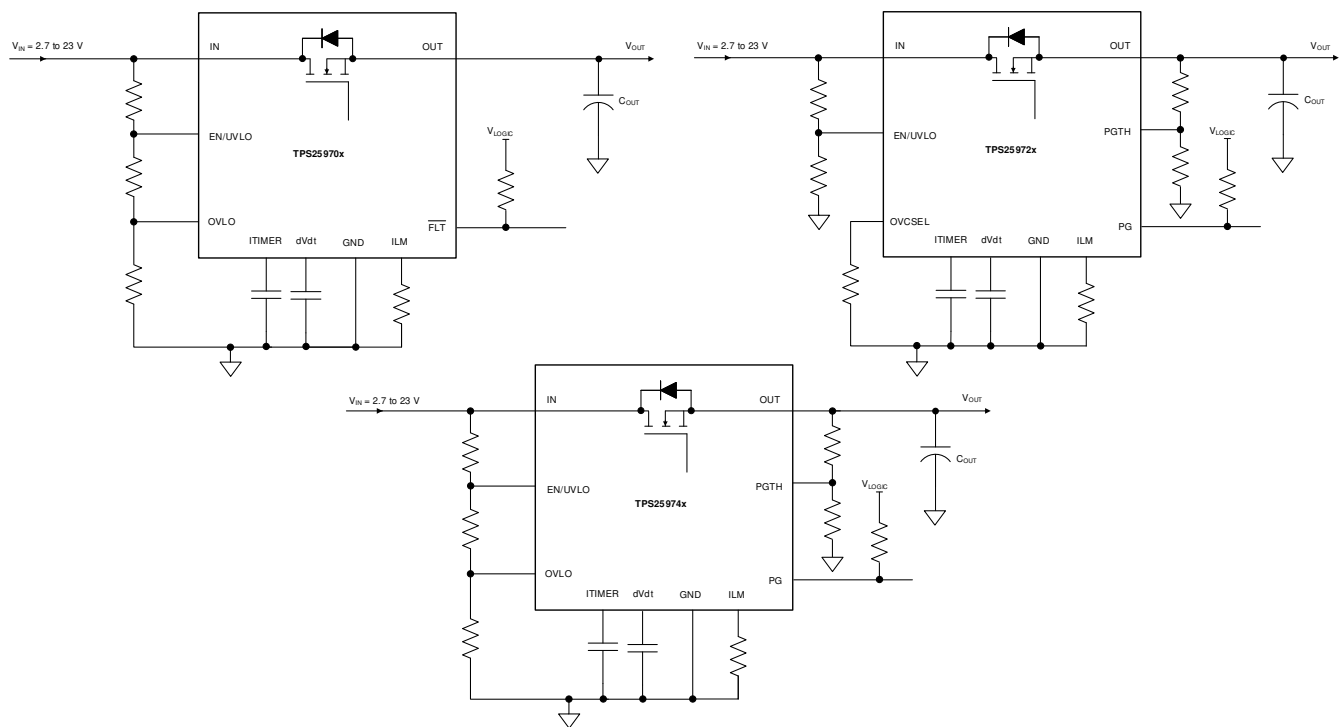

Figure 9-1. Single Device, Self-Controlled

Other variations:

In a Host MCU controlled system, EN/UVLO or OVLO can also be driven from the host GPIO to control the device.

ILM pin can be connected to the MCU ADC input for current monitoring purpose.

Note

TI recommends to keep parasitic capacitance on ILM pin below 50 pF to ensure stable operation.

For the TPS25972x and TPS25974x variants, either V_{IN} or V_{OUT} can be used to drive the PGTH resistor divider depending on which supply must be monitored for Power Good indication.

9.2 Typical Application

TPS2597xx can be used for server add-on card input power protection. During overcurrent or short-circuit event at load side, TPS2597xx can quickly respond to this fault event by turning off the device and thus protect the load from damage as well as prevent input supply from drooping. The ITIMER feature allows short duration peak currents to pass through without tripping the eFuse, thereby meeting the transient load current profile of these cards.

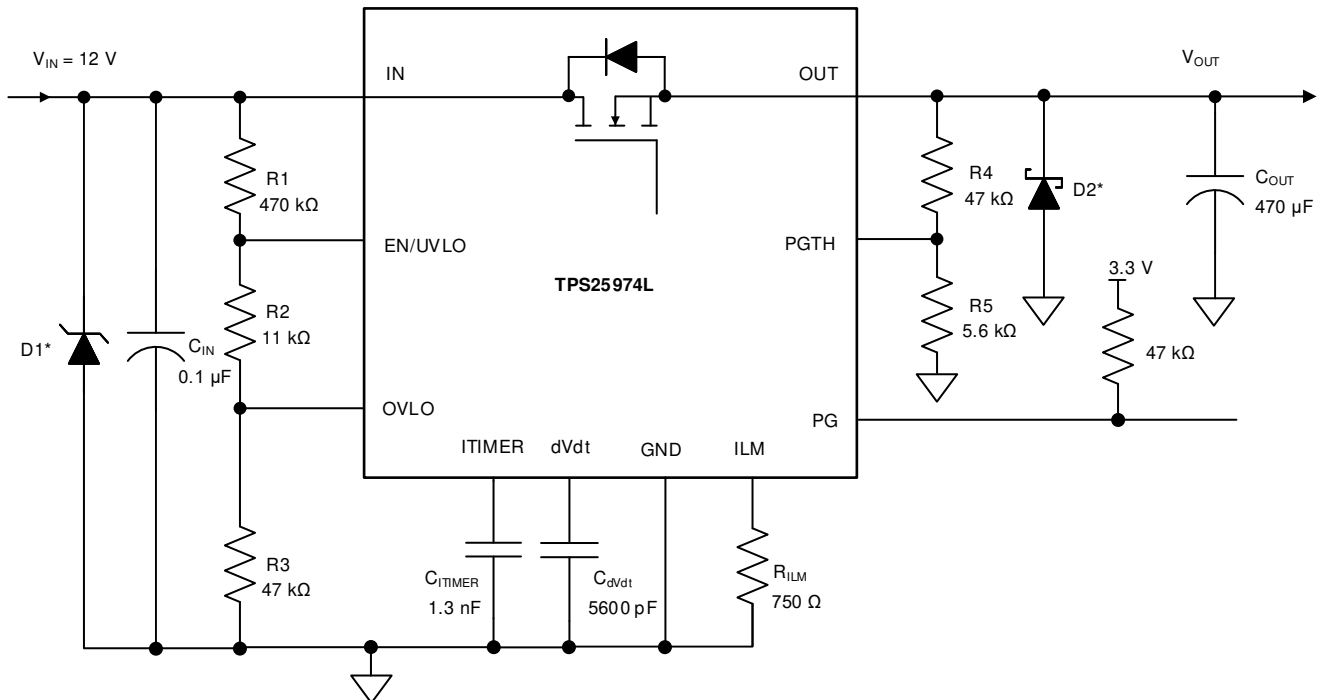

* Optional circuit components needed for transient protection depending on input and output inductance. Please refer to [Transient Protection](#) section for details.

Figure 9-2. Server Add-on Card Input Power Protection

9.2.1 Design Requirements

Table 9-1. Design Parameters

PARAMETER	VALUE
Input supply voltage (V_{IN})	12 V
Undervoltage threshold ($V_{IN(UV)}$)	10.8 V
Overvoltage threshold ($V_{IN(OV)}$)	13.2 V
Output Power Good threshold (V_{PG})	11.4 V
Maximum continuous current	7 A
Load transient blanking interval (t_{TIMER})	1 ms
Output capacitance (C_{OUT})	470 μ F
Output rise time (t_R)	20 ms
Overcurrent threshold (I_{LIM})	7.7 A
Overcurrent response	Circuit breaker
Fault response	Latch-off

9.2.2 Detailed Design Procedure

9.2.2.1 Device Selection

Because the application requires circuit-breaker response to overcurrent with latch-off response after a fault, the TPS25974L variant is selected after referring to the [Device Comparison Table](#).

9.2.2.2 Setting Undervoltage and Overvoltage Thresholds

The supply undervoltage and overvoltage thresholds are set using the resistors R1, R2, and R3, whose values can be calculated using [Equation 10](#) and [Equation 11](#):

$$V_{IN(UV)} = \frac{V_{UVLO(R)} \times (R1 + R2 + R3)}{R2 + R3} \quad (10)$$

$$V_{IN(OV)} = \frac{V_{OV(R)} \times (R1 + R2 + R3)}{R3} \quad (11)$$

Where $V_{UVLO(R)}$ is the UVLO rising threshold and $V_{OV(R)}$ is the OVLO rising threshold. Because R1, R2, and R3 leak the current from input supply V_{IN} , these resistors must be selected based on the acceptable leakage current from input power supply V_{IN} . The current drawn by R1, R2, and R3 from the power supply is $I_{R123} = V_{IN} / (R1 + R2 + R3)$. However, leakage currents due to external active components connected to the resistor string can add error to these calculations. So, the resistor string current, I_{R123} must be chosen to be 20 times greater than the leakage current expected on the EN/UVLO and OVLO pins.

From the device electrical specifications, both the EN/UVLO and OVLO leakage currents are 0.1 μ A (maximum), $V_{OV(R)} = 1.2$ V and $V_{UVLO(R)} = 1.2$ V. From design requirements, $V_{IN(OV)} = 13.2$ V and $V_{IN(UV)} = 10.8$ V. To solve the equation, first choose the value of R1 = 470 k Ω and use the above equations to solve for R2 = 10.7 k Ω and R3 = 48 k Ω .

Using the closest standard 1% resistor values, we get R1 = 470 k Ω , R2 = 11 k Ω , and R3 = 47 k Ω .

9.2.2.3 Setting Output Voltage Rise Time (t_R)

For a successful design, the junction temperature of the device must be kept below the absolute maximum rating during both dynamic (start-up) and steady-state conditions. Dynamic power stresses often are an order of magnitude greater than the static stresses, so it is important to determine the right start-up time and inrush current limit required with system capacitance to avoid thermal shutdown during start-up.

The slew rate (SR) needed to achieve the desired output rise time can be calculated as:

$$SR (V/ms) = \frac{V_{IN} (V)}{t_R (ms)} = \frac{12 V}{20 ms} = 0.6 V/ms \quad (12)$$

The C_{dVdt} needed to achieve this slew rate can be calculated as:

$$C_{dVdt} \text{ (pF)} = \frac{3300}{SR \text{ (V/ms)}} = \frac{3300}{0.6} = 5500 \text{ pF} \quad (13)$$

Choose the nearest standard capacitor value as 5600 pF.

For this slew rate, the inrush current can be calculated as:

$$I_{INRUSH} \text{ (mA)} = SR \text{ (V/ms)} \times C_{OUT} \text{ (}\mu\text{F)} = 0.6 \times 470 = 282 \text{ mA} \quad (14)$$

The average power dissipation inside the part during inrush can be calculated as:

$$P_{DINRUSH} \text{ (W)} = \frac{I_{INRUSH} \text{ (A)} \times V_{IN} \text{ (V)}}{2} = \frac{0.282 \times 12}{2} = 1.69 \text{ W} \quad (15)$$

For the given power dissipation, the thermal shutdown time of the device must be greater than the ramp-up time t_R to avoid start-up failure. Figure 9-3 shows the thermal shutdown limit. For 1.69 W of power, the shutdown time is more than 10 s, which is very large as compared to $t_R = 20$ ms. Therefore, it is safe to use 20 ms as the start-up time for this application.

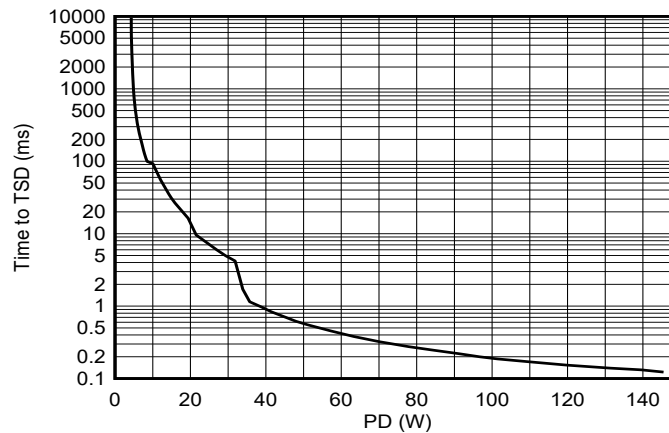

Figure 9-3. Thermal Shut-Down Plot During Inrush

Note

In some systems, there can be active load circuits (for example, DC-DC converters) with low turn-on threshold voltages which can start drawing power before the eFuse has completed the inrush sequence. This action can cause additional power dissipation inside the eFuse during start-up and can lead to thermal shutdown. TI recommends to use the Power Good (PG) pin of the eFuse to enable and disable the load circuit. This action ensures that the load is turned on only when the eFuse has completed its start-up and is ready to deliver full power without the risk of hitting thermal shutdown.

9.2.2.4 Setting Power-Good Assertion Threshold

The Power Good assertion threshold can be set using the resistors R4 and R5 connected to the PGTH pin, whose values can be calculated as:

$$V_{PG} = \frac{V_{PGTH(R)} \times (R4 + R5)}{R5} \quad (16)$$

Because R4 and R5 leak the current from the output rail V_{OUT} , these resistors must be selected to minimize the leakage current. The current drawn by R4 and R5 from the power supply is $I_{R45} = V_{OUT} / (R4 + R5)$. However, leakage currents due to external active components connected to the resistor string can add error to these calculations. So, the resistor string current, I_{R123} must be chosen to be 20 times greater than the PGTH leakage current expected.

From the device electrical specifications, PGTH leakage current is 1 μA (maximum), $V_{\text{PGTH(R)}} = 1.2\text{ V}$ and from design requirements, $V_{\text{PG}} = 11.4\text{ V}$. To solve the equation, first choose the value of $R_4 = 47\text{ k}\Omega$ and calculate $R_5 = 5.52\text{ k}\Omega$. Choose the nearest 1% standard resistor value as $R_5 = 5.6\text{ k}\Omega$.

9.2.2.5 Setting Overcurrent Threshold (I_{LIM})

The overcurrent protection (Circuit Breaker) threshold can be set using the R_{ILM} resistor whose value can be calculated as:

$$R_{\text{ILM}} (\Omega) = \frac{5747}{I_{\text{LIM}} (\text{A})} = \frac{5747}{7.7\text{ A}} = 746.4\ \Omega \quad (17)$$

Choose nearest 1% standard resistor value as 715 Ω .

9.2.2.6 Setting Overcurrent Blanking Interval (t_{TIMER})

The overcurrent blanking timer interval can be set using the C_{TIMER} capacitor whose value can be calculated as:

$$C_{\text{TIMER}} (\text{nF}) = \frac{t_{\text{TIMER}} (\text{ms}) \times I_{\text{TIMER}} (\mu\text{A})}{\Delta V_{\text{TIMER}} (\text{V})} = \frac{1 \times 2}{1.52} = 1.32\text{ nF} \quad (18)$$

Choose nearest standard capacitor value as 1.3 nF.

9.2.3 Application Curves

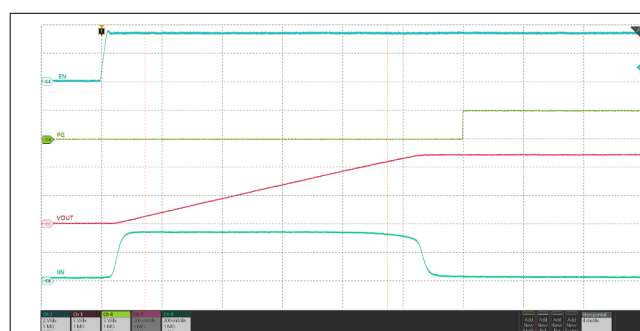

Figure 9-4. Power Up

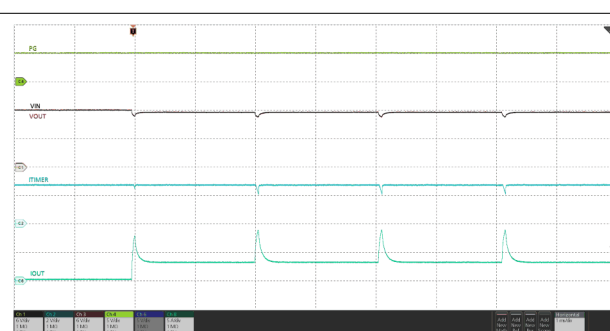

Figure 9-5. Transient Overload

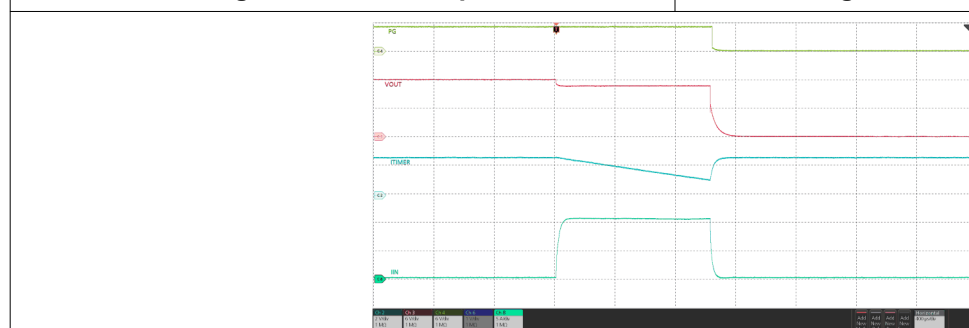

Figure 9-6. Circuit Breaker Response

9.3 Parallel Operation

Applications that need higher steady current can use two TPS25974x devices connected in parallel as shown in Figure 9-7. In this configuration, the first device turns on initially to provide the inrush current control. The second device is held in an OFF state by driving its EN/UVLO pin low using the PG signal of the first device. After the inrush sequence is complete, the first device asserts its PG pin high and turns on the second device. The second device asserts its PG signal to indicate when it has turned on fully, thereby indicating to the system that the parallel combination is ready to deliver the full steady state current.

After in steady state, both devices share current nearly equally. There can be a slight skew in the currents depending on the part-to-part variation in the R_{ON} as well as the PCB trace resistance mismatch.

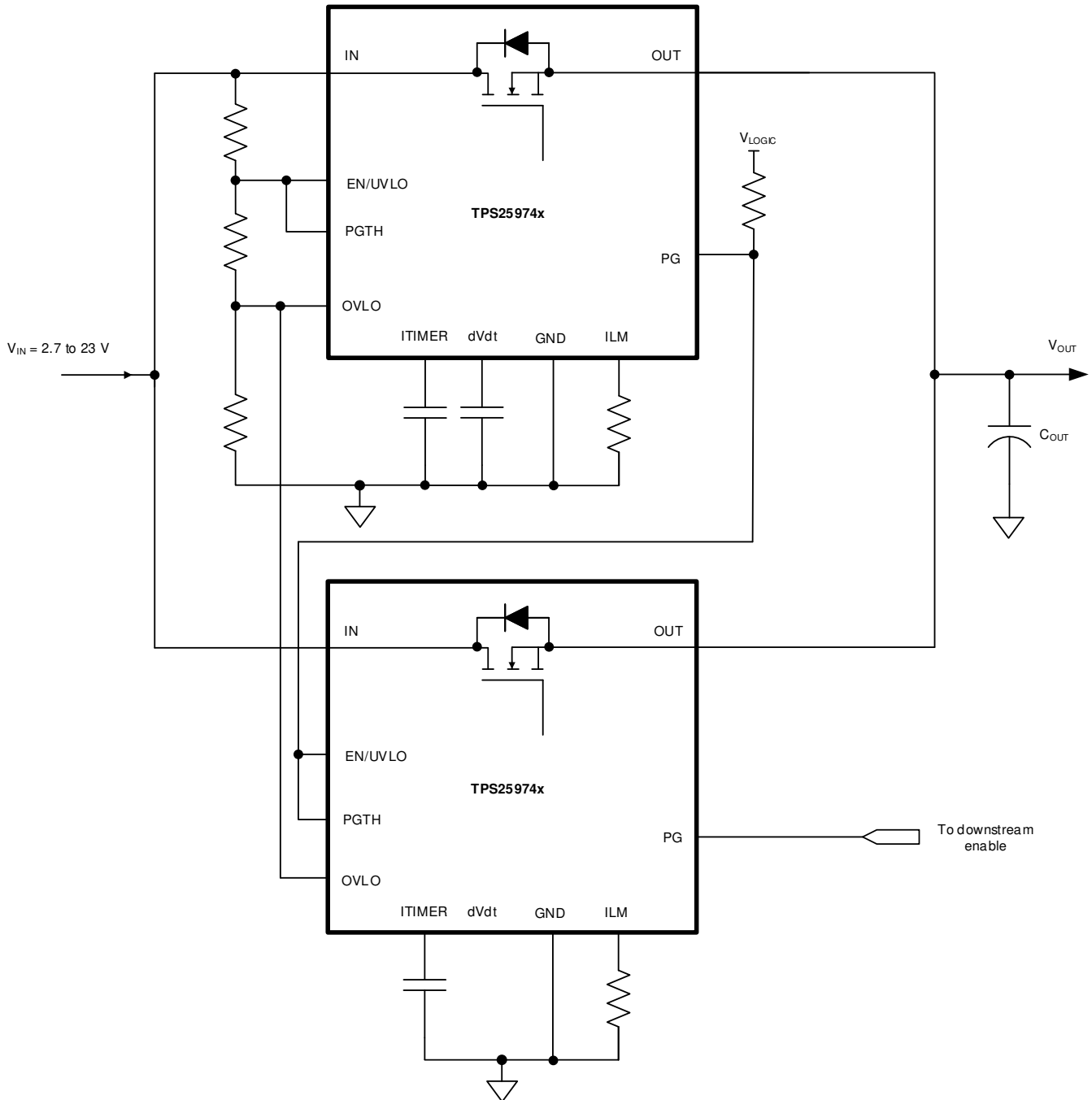

Figure 9-7. Two Devices Connected in Parallel for Higher Steady State Current Capability

The waveforms below illustrate the behavior of the parallel configuration during start-up as well as during steady state.

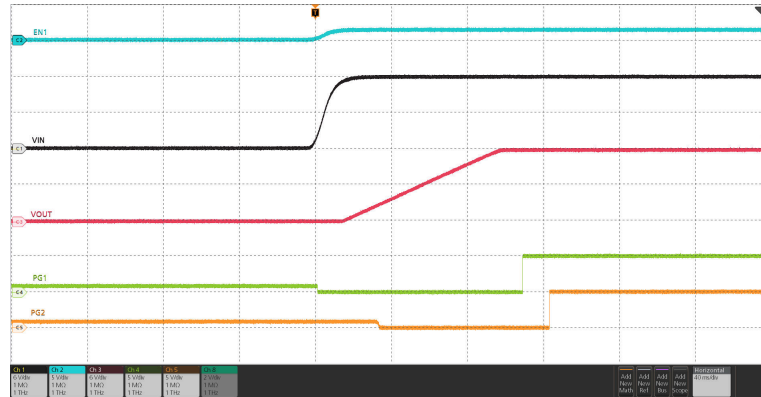

Figure 9-8. Parallel Devices Sequencing During Start-Up



Figure 9-9. Parallel Devices Load Current During Steady State and Overload

9.4 Power Supply Recommendations

The TPS2597xx devices are designed for a supply voltage range of $2.7\text{ V} \leq V_{IN} \leq 23\text{ V}$. TI recommends an input ceramic bypass capacitor higher than $0.1\text{ }\mu\text{F}$ if the input supply is located more than a few inches from the device. The power supply must be rated higher than the set current limit to avoid voltage droops during overcurrent and short-circuit conditions.

9.4.1 Transient Protection

In the case of a short-circuit and overload current limit when the device interrupts current flow, the input inductance generates a positive voltage spike on the input, and the output inductance generates a negative voltage spike on the output. The peak amplitude of voltage spikes (transients) is dependent on the value of inductance in series to the input or output of the device. Such transients can exceed the absolute maximum ratings of the device if steps are not taken to address the issue. Typical methods for addressing transients include:

- Minimize lead length and inductance into and out of the device.
- Use a large PCB GND plane.
- Connect a Schottky diode from the OUT pin ground to absorb negative spikes.
- Connect a low ESR capacitor larger than $1\text{ }\mu\text{F}$ at the OUT pin very close to the device.
- Use a low-value ceramic capacitor $C_{IN} = 1\text{ }\mu\text{F}$ to absorb the energy and dampen the transients. The capacitor voltage rating must be at least twice the input supply voltage to be able to withstand the positive voltage excursion during inductive ringing.

Use [Equation 19](#) to estimate the approximate value of input capacitance:

$$V_{SPIKE(Absolute)} = V_{IN} + I_{LOAD} \times \sqrt{\frac{L_{IN}}{C_{IN}}} \quad (19)$$

where

- V_{IN} is the nominal supply voltage.
- I_{LOAD} is the load current.
- L_{IN} equals the effective inductance seen looking into the source.
- C_{IN} is the capacitance present at the input.
- Some applications can require the addition of a Transient Voltage Suppressor (TVS) to prevent transients from exceeding the absolute maximum ratings of the device. In some cases, even if the maximum amplitude of the transients is below the absolute maximum rating of the device, a TVS can help to absorb the excessive energy dump and prevent it from creating very fast transient voltages on the input supply pin of the IC, which can couple to the internal control circuits and cause unexpected behavior.

Figure 9-10 shows the circuit implementation with optional protection components.

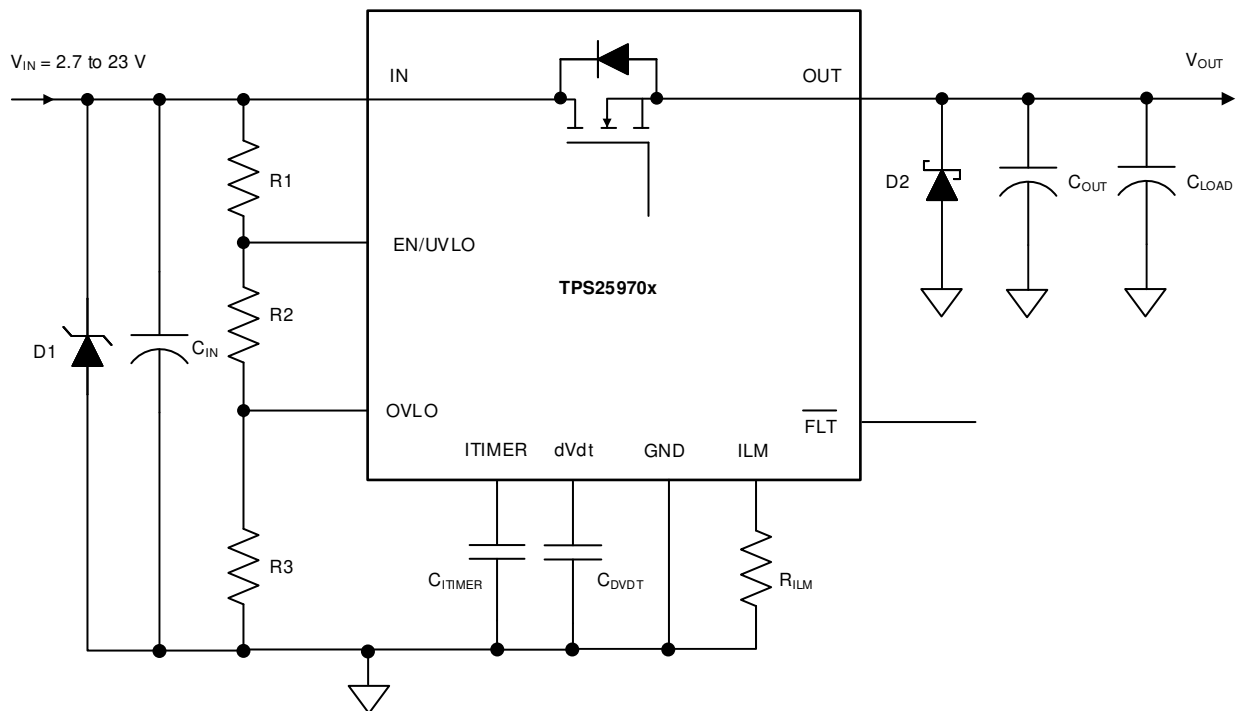

Figure 9-10. Circuit Implementation With Optional Protection Components

9.4.2 Output Short-Circuit Measurements

It is difficult to obtain repeatable and similar short-circuit testing results. The following contribute to variation in results:

- Source bypassing
- Input leads
- Circuit layout
- Component selection
- Output shorting method
- Relative location of the short
- Instrumentation



The actual short exhibits a certain degree of randomness because it microscopically bounces and arcs. Ensure that configuration and methods are used to obtain realistic results. Do not expect to see waveforms exactly like those in this data sheet because every setup is different.

9.5 Layout

9.5.1 Layout Guidelines

- For all applications, TI recommends a ceramic decoupling capacitor of 0.1 μF or greater between the IN terminal and GND terminal.
- The optimal placement of the decoupling capacitor is closest to the IN and GND terminals of the device. Care must be taken to minimize the loop area formed by the bypass-capacitor connection, the IN terminal, and the GND terminal of the IC.
- High current-carrying power-path connections must be as short as possible and must be sized to carry at least twice the full-load current.
- The GND terminal must be tied to the PCB ground plane at the terminal of the IC with the shortest possible trace. The PCB ground must be a copper plane or island on the board. TI recommends to have a separate ground plane island for the eFuse. This plane does not carry any high currents and serves as a quiet ground reference for all the critical analog signals of the eFuse. The device ground plane must be connected to the system power ground plane using a star connection.
- The IN and OUT pins are used for heat dissipation. Connect to as much copper area on top and bottom PCB layers using as possible with thermal vias. The vias under the device also help to minimize the voltage gradient across the IN and OUT pads and distribute current uniformly through the device, which is essential to achieve the best on-resistance and current sense accuracy.
- Locate the following support components close to their connection pins:
 - R_{ILM}
 - C_{dVdT}
 - C_{TIMER}
 - Resistors for the EN/UVLO, OVLO/OVCSEL, and PGTH pins
- Connect the other end of the component to the GND pin of the device with shortest trace length. The trace routing for the R_{ILM} , C_{TIMER} and C_{dVdT} components to the device must be as short as possible to reduce parasitic effects on the current limit, overcurrent blanking interval and soft start timing. It's recommended to keep parasitic capacitance on ILM pin below 50 pF to ensure stable operation. These traces must not have any coupling to switching signals on the board.
- Because the bias current on ILM pin directly controls the overcurrent protection behavior of the device, the PCB routing of this node must be kept away from any noisy (switching) signals.
- Protection devices such as TVS, snubbers, capacitors, or diodes must be placed physically close to the device they are intended to protect. These protection devices must be routed with short traces to reduce inductance. For example, TI recommends a protection Schottky diode to address negative transients due to switching of inductive loads. TI also recommends to add a ceramic decoupling capacitor of 1 μF or greater between OUT and GND. These components must be physically close to the OUT pins. Care must be taken to minimize the loop area formed by the Schottky diode/bypass-capacitor connection, the OUT pin, and the GND terminal of the IC.

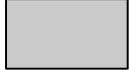
9.5.2 Layout Example

-  Inner GND layer
-  Top Power layer
-  Bottom Power layer

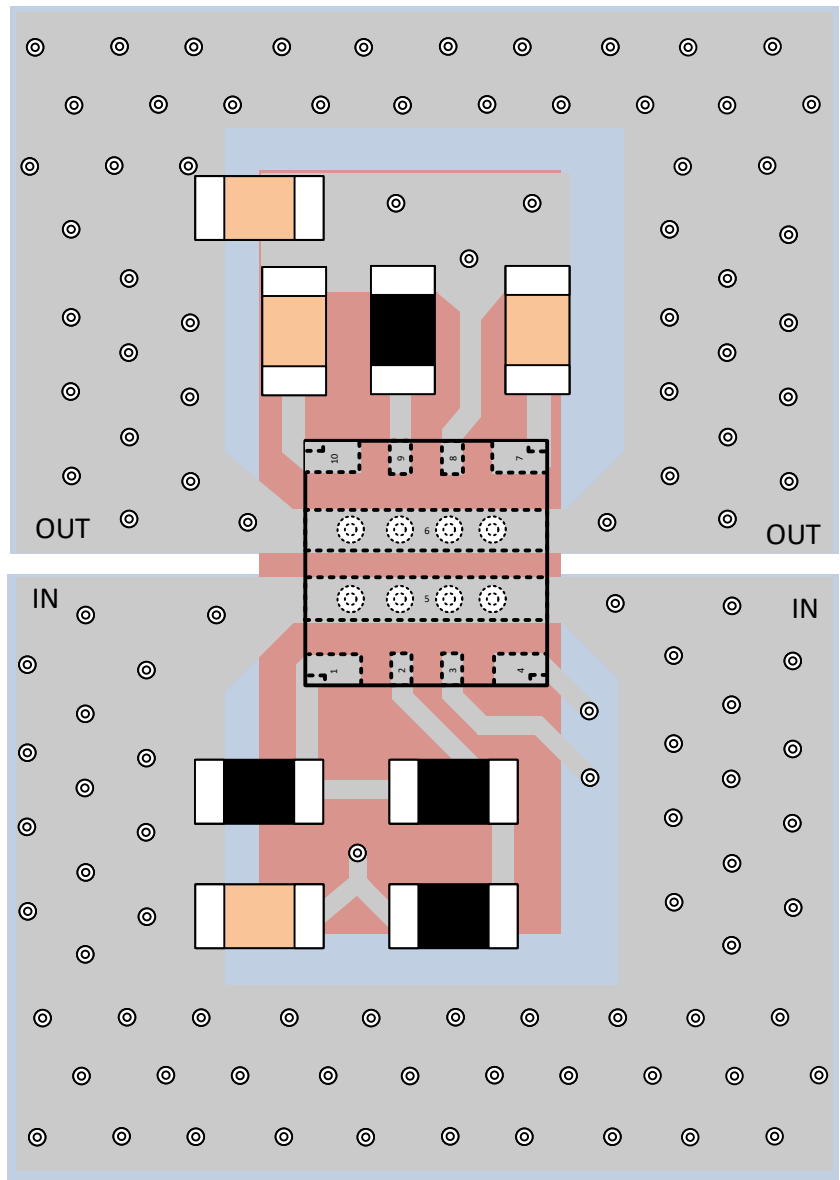

Figure 9-11. Layout Example - Single TPS25974x With PGTH Referred to OUT

10 Device and Documentation Support

TI offers an extensive line of development tools. Tools and software to evaluate the performance of the device, generate code, and develop solutions are listed below.

10.1 Device Support

10.1.1 Third-Party Products Disclaimer

TI'S PUBLICATION OF INFORMATION REGARDING THIRD-PARTY PRODUCTS OR SERVICES DOES NOT CONSTITUTE AN ENDORSEMENT REGARDING THE SUITABILITY OF SUCH PRODUCTS OR SERVICES OR A WARRANTY, REPRESENTATION OR ENDORSEMENT OF SUCH PRODUCTS OR SERVICES, EITHER ALONE OR IN COMBINATION WITH ANY TI PRODUCT OR SERVICE.

10.2 Documentation Support

10.2.1 Related Documentation

For related documentation see the following:

- Texas Instruments, [TPS2597EVM eFuse Evaluation Board user's guide](#)
- Texas Instruments, [TPS2597xx Design Calculator](#)

10.3 Receiving Notification of Documentation Updates

To receive notification of documentation updates, navigate to the device product folder on [ti.com](#). Click on *Subscribe to updates* to register and receive a weekly digest of any product information that has changed. For change details, review the revision history included in any revised document.

10.4 Support Resources

[TI E2E™ support forums](#) are an engineer's go-to source for fast, verified answers and design help — straight from the experts. Search existing answers or ask your own question to get the quick design help you need.

Linked content is provided "AS IS" by the respective contributors. They do not constitute TI specifications and do not necessarily reflect TI's views; see TI's [Terms of Use](#).

10.5 Trademarks

HotRod™ and TI E2E™ are trademarks of Texas Instruments.

All trademarks are the property of their respective owners.

10.6 Electrostatic Discharge Caution



This integrated circuit can be damaged by ESD. Texas Instruments recommends that all integrated circuits be handled with appropriate precautions. Failure to observe proper handling and installation procedures can cause damage.

ESD damage can range from subtle performance degradation to complete device failure. Precision integrated circuits may be more susceptible to damage because very small parametric changes could cause the device not to meet its published specifications.

10.7 Glossary

[TI Glossary](#) This glossary lists and explains terms, acronyms, and definitions.

11 Mechanical, Packaging, and Orderable Information

The following pages include mechanical, packaging, and orderable information. This information is the most current data available for the designated devices. This data is subject to change without notice and revision of this document. For browser-based versions of this data sheet, refer to the left-hand navigation.

PACKAGING INFORMATION

Orderable Device	Status (1)	Package Type	Package Drawing	Pins	Package Qty	Eco Plan (2)	Lead finish/ Ball material (6)	MSL Peak Temp (3)	Op Temp (°C)	Device Marking (4/5)	Samples
TPS25970ARPWR	ACTIVE	VQFN-HR	RPW	10	3000	RoHS & Green	NIPDAU	Level-2-260C-1 YEAR	-40 to 125	2KNH	Samples
TPS25970LRPWR	ACTIVE	VQFN-HR	RPW	10	3000	RoHS & Green	NIPDAU	Level-2-260C-1 YEAR	-40 to 125	2KOH	Samples
TPS25972ARPWR	ACTIVE	VQFN-HR	RPW	10	3000	RoHS & Green	NIPDAU	Level-2-260C-1 YEAR	-40 to 125	2KPH	Samples
TPS25972LRPWR	ACTIVE	VQFN-HR	RPW	10	3000	RoHS & Green	NIPDAU	Level-2-260C-1 YEAR	-40 to 125	2KQH	Samples
TPS25974ARPWR	ACTIVE	VQFN-HR	RPW	10	3000	RoHS & Green	NIPDAU	Level-2-260C-1 YEAR	-40 to 125	2KRH	Samples
TPS25974LRPWR	ACTIVE	VQFN-HR	RPW	10	3000	RoHS & Green	NIPDAU	Level-2-260C-1 YEAR	-40 to 125	2KSH	Samples

(1) The marketing status values are defined as follows:

ACTIVE: Product device recommended for new designs.

LIFEBUY: TI has announced that the device will be discontinued, and a lifetime-buy period is in effect.

NRND: Not recommended for new designs. Device is in production to support existing customers, but TI does not recommend using this part in a new design.

PREVIEW: Device has been announced but is not in production. Samples may or may not be available.

OBSOLETE: TI has discontinued the production of the device.

(2) **RoHS:** TI defines "RoHS" to mean semiconductor products that are compliant with the current EU RoHS requirements for all 10 RoHS substances, including the requirement that RoHS substance do not exceed 0.1% by weight in homogeneous materials. Where designed to be soldered at high temperatures, "RoHS" products are suitable for use in specified lead-free processes. TI may reference these types of products as "Pb-Free".

RoHS Exempt: TI defines "RoHS Exempt" to mean products that contain lead but are compliant with EU RoHS pursuant to a specific EU RoHS exemption.

Green: TI defines "Green" to mean the content of Chlorine (Cl) and Bromine (Br) based flame retardants meet JS709B low halogen requirements of <=1000ppm threshold. Antimony trioxide based flame retardants must also meet the <=1000ppm threshold requirement.

(3) MSL, Peak Temp. - The Moisture Sensitivity Level rating according to the JEDEC industry standard classifications, and peak solder temperature.

(4) There may be additional marking, which relates to the logo, the lot trace code information, or the environmental category on the device.

(5) Multiple Device Markings will be inside parentheses. Only one Device Marking contained in parentheses and separated by a "~" will appear on a device. If a line is indented then it is a continuation of the previous line and the two combined represent the entire Device Marking for that device.

(6) Lead finish/Ball material - Orderable Devices may have multiple material finish options. Finish options are separated by a vertical ruled line. Lead finish/Ball material values may wrap to two lines if the finish value exceeds the maximum column width.

Important Information and Disclaimer: The information provided on this page represents TI's knowledge and belief as of the date that it is provided. TI bases its knowledge and belief on information provided by third parties, and makes no representation or warranty as to the accuracy of such information. Efforts are underway to better integrate information from third parties. TI has taken and continues to take reasonable steps to provide representative and accurate information but may not have conducted destructive testing or chemical analysis on incoming materials and chemicals. TI and TI suppliers consider certain information to be proprietary, and thus CAS numbers and other limited information may not be available for release.

In no event shall TI's liability arising out of such information exceed the total purchase price of the TI part(s) at issue in this document sold by TI to Customer on an annual basis.

TAPE AND REEL INFORMATION

QUADRANT ASSIGNMENTS FOR PIN 1 ORIENTATION IN TAPE



*All dimensions are nominal

Device	Package Type	Package Drawing	Pins	SPQ	Reel Diameter (mm)	Reel Width W1 (mm)	A0 (mm)	B0 (mm)	K0 (mm)	P1 (mm)	W (mm)	Pin1 Quadrant
TPS25970ARPWR	VQFN-HR	RPW	10	3000	180.0	8.4	2.3	2.3	1.15	4.0	8.0	Q2
TPS25970LRPWR	VQFN-HR	RPW	10	3000	180.0	8.4	2.3	2.3	1.15	4.0	8.0	Q2
TPS25972ARPWR	VQFN-HR	RPW	10	3000	180.0	8.4	2.3	2.3	1.15	4.0	8.0	Q2
TPS25972LRPWR	VQFN-HR	RPW	10	3000	180.0	8.4	2.3	2.3	1.15	4.0	8.0	Q2
TPS25974ARPWR	VQFN-HR	RPW	10	3000	180.0	8.4	2.3	2.3	1.15	4.0	8.0	Q2
TPS25974LRPWR	VQFN-HR	RPW	10	3000	180.0	8.4	2.3	2.3	1.15	4.0	8.0	Q2

TAPE AND REEL BOX DIMENSIONS

*All dimensions are nominal

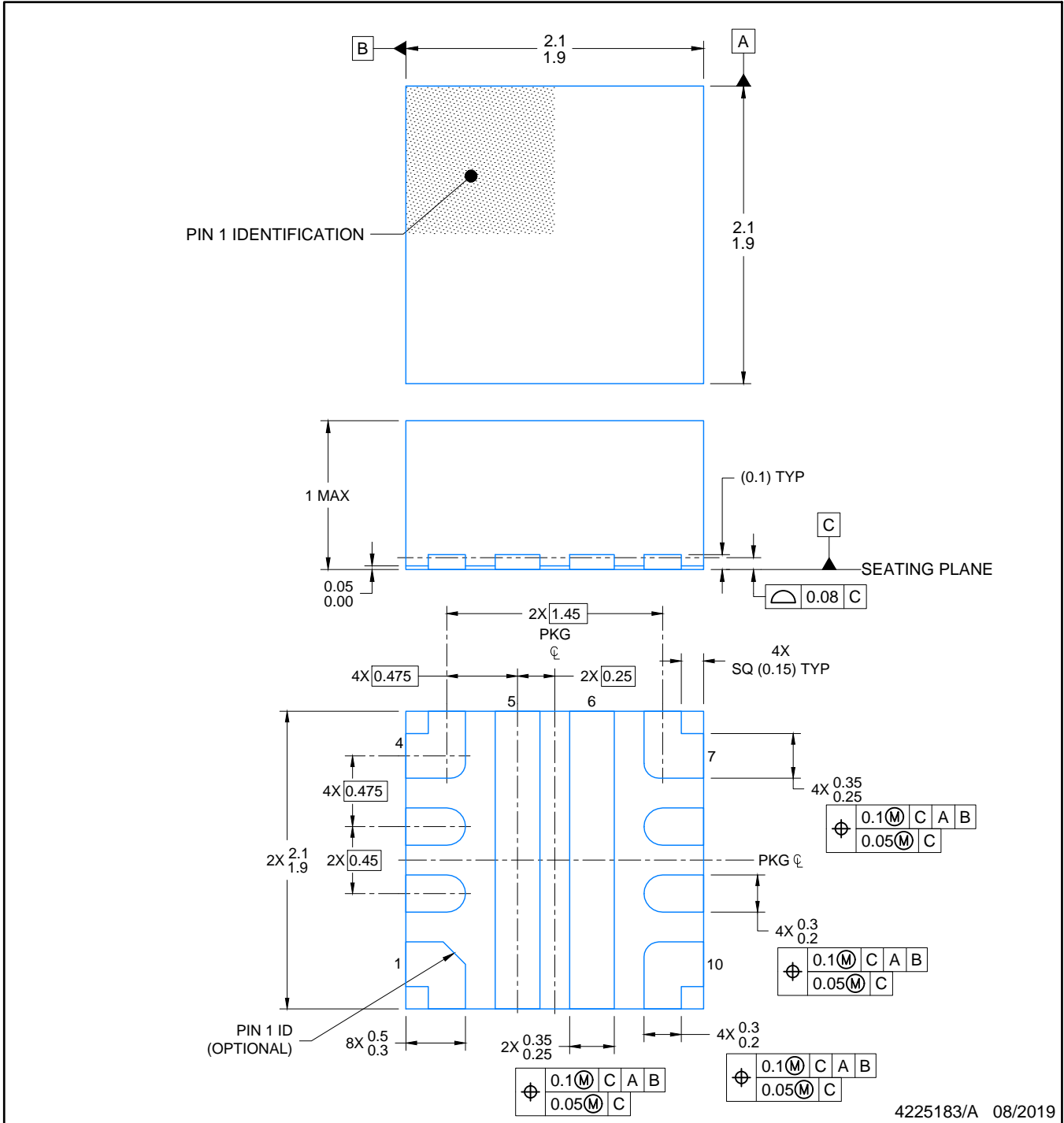
Device	Package Type	Package Drawing	Pins	SPQ	Length (mm)	Width (mm)	Height (mm)
TPS25970ARPWR	VQFN-HR	RPW	10	3000	210.0	185.0	35.0
TPS25970LRPWR	VQFN-HR	RPW	10	3000	210.0	185.0	35.0
TPS25972ARPWR	VQFN-HR	RPW	10	3000	210.0	185.0	35.0
TPS25972LRPWR	VQFN-HR	RPW	10	3000	210.0	185.0	35.0
TPS25974ARPWR	VQFN-HR	RPW	10	3000	210.0	185.0	35.0
TPS25974LRPWR	VQFN-HR	RPW	10	3000	210.0	185.0	35.0



4225183/A 08/2019

NOTES:

1. All linear dimensions are in millimeters. Any dimensions in parenthesis are for reference only. Dimensioning and tolerancing per ASME Y14.5M.
2. This drawing is subject to change without notice.

EXAMPLE STENCIL DESIGN

RPW0010A

VQFN-HR - 1 mm max height

PLASTIC QUAD FLATPACK - NO LEAD

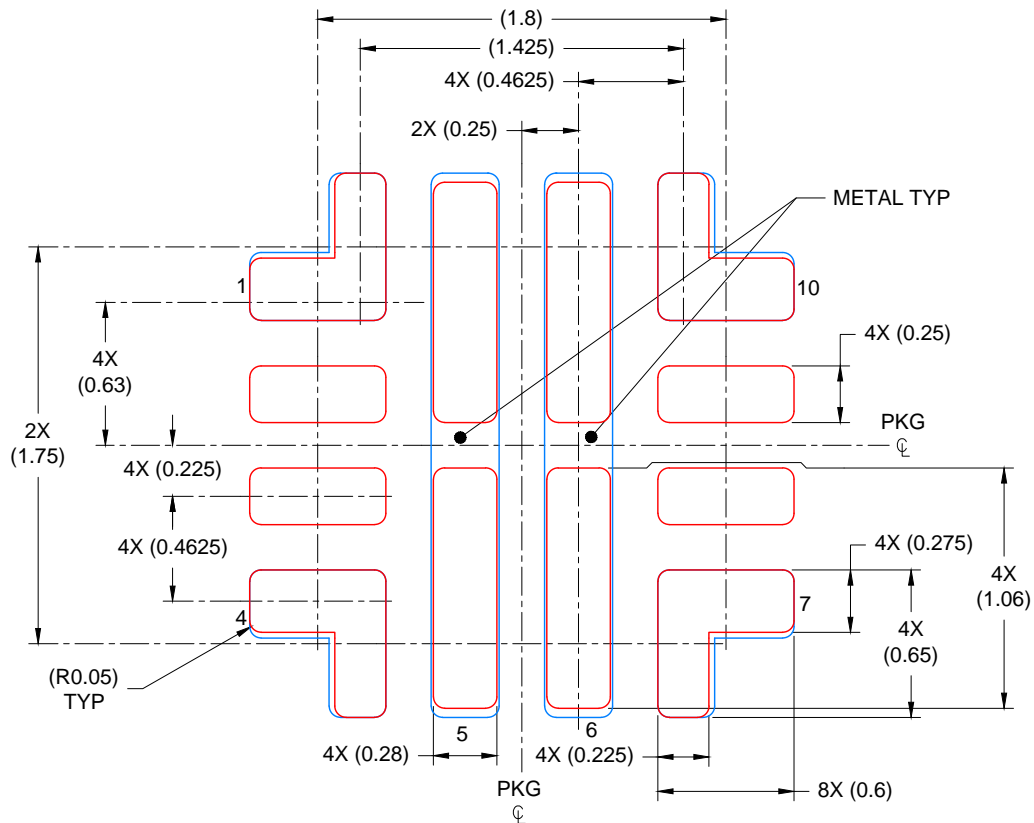

SOLDER PASTE EXAMPLE
BASED ON 0.100 mm THICK STENCIL

PADS 1, 4, 7 & 10: 93%; PADS 5 & 6: 82%
SCALE: 30X

4225183/A 08/2019

NOTES: (continued)

5. Laser cutting apertures with trapezoidal walls and rounded corners may offer better paste release. IPC-7525 may have alternate design recommendations.

IMPORTANT NOTICE AND DISCLAIMER

TI PROVIDES TECHNICAL AND RELIABILITY DATA (INCLUDING DATA SHEETS), DESIGN RESOURCES (INCLUDING REFERENCE DESIGNS), APPLICATION OR OTHER DESIGN ADVICE, WEB TOOLS, SAFETY INFORMATION, AND OTHER RESOURCES "AS IS" AND WITH ALL FAULTS, AND DISCLAIMS ALL WARRANTIES, EXPRESS AND IMPLIED, INCLUDING WITHOUT LIMITATION ANY IMPLIED WARRANTIES OF MERCHANTABILITY, FITNESS FOR A PARTICULAR PURPOSE OR NON-INFRINGEMENT OF THIRD PARTY INTELLECTUAL PROPERTY RIGHTS.

These resources are intended for skilled developers designing with TI products. You are solely responsible for (1) selecting the appropriate TI products for your application, (2) designing, validating and testing your application, and (3) ensuring your application meets applicable standards, and any other safety, security, regulatory or other requirements.

These resources are subject to change without notice. TI grants you permission to use these resources only for development of an application that uses the TI products described in the resource. Other reproduction and display of these resources is prohibited. No license is granted to any other TI intellectual property right or to any third party intellectual property right. TI disclaims responsibility for, and you will fully indemnify TI and its representatives against, any claims, damages, costs, losses, and liabilities arising out of your use of these resources.

TI's products are provided subject to [TI's Terms of Sale](#) or other applicable terms available either on [ti.com](https://www.ti.com) or provided in conjunction with such TI products. TI's provision of these resources does not expand or otherwise alter TI's applicable warranties or warranty disclaimers for TI products.

TI objects to and rejects any additional or different terms you may have proposed.

Mailing Address: Texas Instruments, Post Office Box 655303, Dallas, Texas 75265
Copyright © 2023, Texas Instruments Incorporated