

## Features

- Integrated Transient Voltage Suppressor (TVS) in the Transceiver IC
- TVS Protection for Bus Terminals :
  - ±15 kV IEC 61000-4-2, Contact Discharge
  - ±18 kV IEC 61000-4-2, Air-Gap Discharge
  - ±15 kV EIA/JEDEC Human Body Model
- HBM ±8kV ESD Protection for all pins
- MM ±800V ESD Protection for all pins
- Latchup immunity up to ±400mA for all pins.
- High CDM protection up to ±1kV for all pins.
- Meet the Requirements of the EIA/TIA-485 Standards with 5V Power Supply
- True Fail-Safe Receiver While Maintaining EIA/TIA-485 Compatibility
- Data Rate up to 10Mbps
- Hot-Swap Glitch free Protection on Control Inputs
- High driving ability of VOD2 up to 2.3V
- Up to 256 Transceivers on the Bus

## Applications

- Motor Control
- Industrial Control
- Security System
- Building Automation Networks

## Description

The AZRS3080E is a ±15kV IEC 61000-4-2 contact discharge protected half-duplex RS485 transceiver IC, which contains one transmitter and one receiver inside. This device is fully compliant with the EIA/TIA-485 standard with 5V power supply.

The AZRS3080E features a fail-safe receiver, which guarantees the output of the receiver to be logic high when the differential inputs (bus pins, A and B) of the receiver are open, short or idle under abnormal operating conditions.

The AZRS3080E features a hot-swap glitch-free design which guarantees outputs of the transmitter and the receiver in a high impedance state and even no short current event during the power up period. The AZRS3080E has the thermal shutdown and the current limited function in the transmitter to protect the device from damage by system fault conditions during normal operating condition. The AZRS3080E is designed 1/8 unit load with minimum 96kohm of input impedance, which can connect 256 devices on a bus at least. The AZRS3080E is also a high reliable device with built-in system level ESD protected devices against high-energy noise transients without requiring any external components.

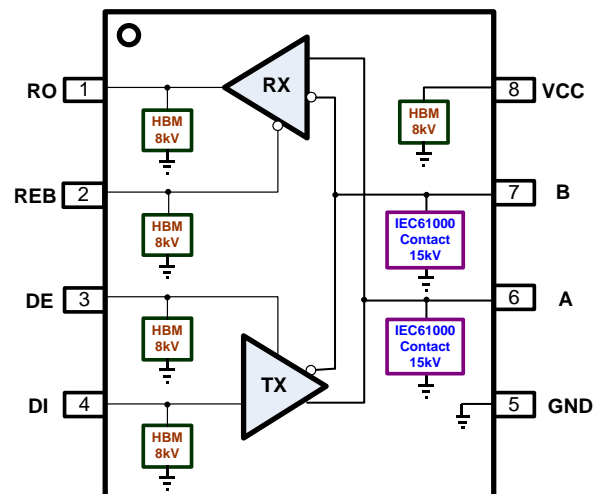

**Functional Block of AZRS3080E**

Part Number	Duplex	Tx/Rx	Supply	Max Data Rate (Mbps)	Fail- safe	HBM on A,B	IEC 61000-4-2 Contact on A,B	Package Type
AZRS3080E	Half	1/1	5	10	Yes	±15kV	± 15kV	SO-8



## ABSOLUTE MAXIMUM RATINGS

PARAMETER	PARAMETER	RATING	UNITS
Power Supply Vcc	Vcc	-0.3 to 8.0	V
Control Input Voltage	REB, DE	-0.3 to (Vcc+ 0.3)	V
Receiver Input Voltage	A, B	±13	V
Receiver Output Voltage	RO	-0.3 to (Vcc+ 0.3)	V
Transmitter Output Voltage	A, B	±13	V
Transmitter Input	DI	-0.3 to (Vcc+ 0.3)	V
Operating Temperature	T <sub>OP</sub>	-40 to +85	°C
Storage Temperature	T <sub>STO</sub>	-65 to +150	°C

## DC ELECTRICAL CHARACTERISTICS

(Vcc=5V ±5% with T<sub>AMB</sub>= T<sub>MIN</sub> to T<sub>MAX</sub>, unless otherwise noted. Typical values are at Vcc=5V and T<sub>AMB</sub>= 25°C.)

PARAMETER	SYMBOL	CONDITIONS	MIN	TYP	MAX	UNITS
<b>Transmitter</b>						
Differential Transmitter Output	V <sub>OD1</sub>	No load			Vcc	V
Differential Transmitter Output	V <sub>OD2</sub>	Fig.1, R <sub>L</sub> = 27Ω	1.5	2.3		V
Change in Magnitude of Differential Output Voltage	ΔV <sub>OD</sub>	Fig.1, R <sub>L</sub> = 27Ω			0.2	V
Transmitter Common- Mode Output Voltage	V <sub>OC</sub>	Fig.1, R <sub>L</sub> = 27Ω			3.0	V
Change in Magnitude of Common- Mode Voltage	ΔV <sub>OC</sub>	Fig.1, R <sub>L</sub> = 27Ω			0.2	V
Input High Voltage	V <sub>IH</sub>	DE, DI, REB	2.0			V
Input Low Voltage	V <sub>IL</sub>	DE, DI, REB			0.8	V
Input Current	I <sub>IN1</sub>	DE, DI, REB			±2	μA
Input Current for A and B	I <sub>IN2</sub>	DE=0, Vcc=0V or 5.25V	V <sub>IN</sub> =12V		125	uA
			V <sub>IN</sub> =-7V	-100		
Transmitter Short-Circuit Output Current	I <sub>OSD</sub>	-7V ≤ V <sub>OUT</sub> ≤ 12V	-250		250	mA
<b>RECEIVER</b>						
Receiver Differential Threshold Voltage	V <sub>TH</sub>		-200		-50	mV
Receiver Input Hysteresis	ΔV <sub>TH</sub>			20		mV
Receiver Output High Voltage	V <sub>OH</sub>	I <sub>o</sub> = -4mA, VID= 200mV	Vcc-1.5			V
Receiver Output Low Voltage	V <sub>OL</sub>	I <sub>o</sub> = 4mA, VID= -200mV			0.4	V
Three- State Output Current at	I <sub>OZR</sub>	0.4V ≤ V <sub>CM</sub> ≤ 2.4V			±1	μA



PARAMETER	SYMBOL	CONDITIONS	MIN	TYP	MAX	UNITS	
<b>RECEIVER</b>							
Receiver Input Resistance	$R_{IN}$	$-7V \leq V_{CM} \leq +12V$	96			$k\Omega$	
Receiver Output Short-Circuit Current	$I_{OSR}$	Fig. 6, $0V \leq V_{RO} \leq V_{CC}$	$\pm 7$		$\pm 95$	m A	
<b>SUPPLY CURRENT</b>							
Supply Current	$I_{CC}$	No load, REB= GND, DI= Vcc or GND.	DE= Vcc		500	900	$\mu A$
			DE= GND		300	500	$\mu A$

## SWITCHING CHARACTERISTICS

( $V_{CC}=5V \pm 5\%$  with  $T_{AMB}= T_{MIN}$  to  $T_{MAX}$ , unless otherwise noted. Typical values are at  $V_{CC}=5V$  and  $T_{AMB}= 25^\circ C$ .)

PARAMETER	SYMBOL	CONDITIONS	MIN	TYP	MAX	UNITS
Transmitter Output Skew $ t_{DPLH} - t_{DPHL} $	$t_{DSKEW}$	Fig.2, Fig.7, $R_{DIFF}=54\Omega$ , $C_{L1}=C_{L2}= 100pF$		5	10	ns
Transmitter Rise or Fall Time	$t_{DF}, t_{DR}$	Fig.2, Fig.7, $R_{DIFF}=54\Omega$ , $C_{L1}=C_{L2}= 100pF$	3	20	40	ns
Data Rate	$f_{Data}$				10	Mbps
Transmitter Enable to Output Low	$t_{DZL}$	Fig.4, Fig.8, $C_{DL}= 100pF$ , S1 closed		45	70	ns
Transmitter Enable to Output High	$t_{DZH}$	Fig.4, Fig.8, $C_{DL}= 100pF$ , S2 closed		45	70	ns
Transmitter Disable Time from Low	$t_{DLZ}$	Fig.4, Fig.8, $C_{DL}= 15pF$ , S1 closed		45	70	ns
Transmitter Disable Time from High	$t_{DHZ}$	Fig.4, Fig.8, $C_{DL}= 15pF$ , S2 closed		45	70	ns
Receiver Input to Output	$t_{RPLH}, t_{RPHL}$	Fig.5, Fig.9, $ V_{ID}  \geq 2.0V$ ; rise and fall time of $V_{ID} \leq 15ns$	20	120	200	ns
$ t_{RPLH} - t_{RPHL} $ Different Receiver Skew	$t_{RSKD}$	Fig.5, Fig.9, $ V_{ID}  \geq 2.0V$ ; rise and fall time of $V_{ID} \leq 15ns$		5		ns
Receiver Enable to Output Low	$t_{RZL}$	Fig.3, Fig.10, $C_{RL}= 15pF$ , S1 closed		20	50	ns
Receiver Enable to Output High	$t_{RZH}$	Fig.3, Fig.10, $C_{RL}= 15pF$ , S2 closed		20	50	ns
Receiver Disable Time from Low	$t_{RLZ}$	Fig.3, Fig.10, $C_{RL}= 15pF$ , S1 closed		20	50	ns
Receiver Disable Time from High	$t_{RHZ}$	Fig.3, Fig.10, $C_{RL}= 15pF$ , S2 closed		20	50	ns

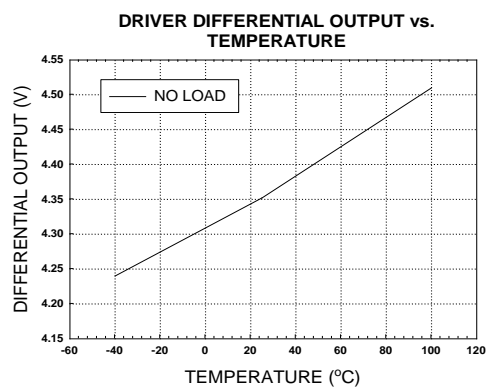
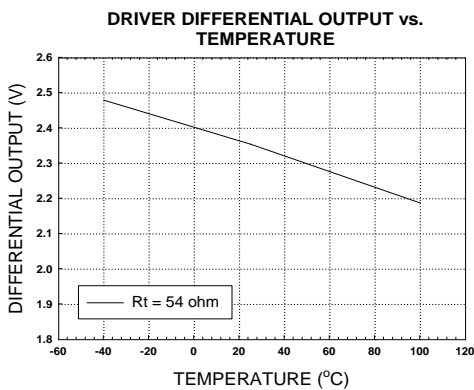
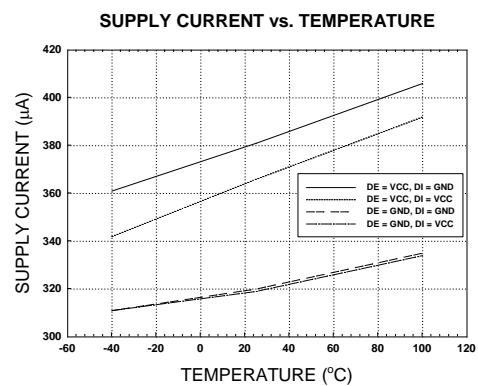
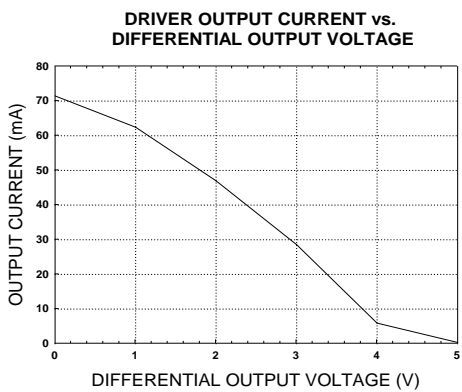
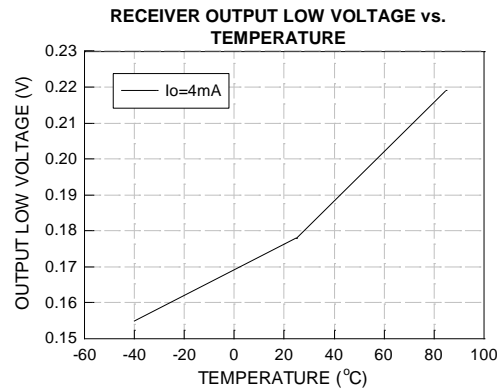
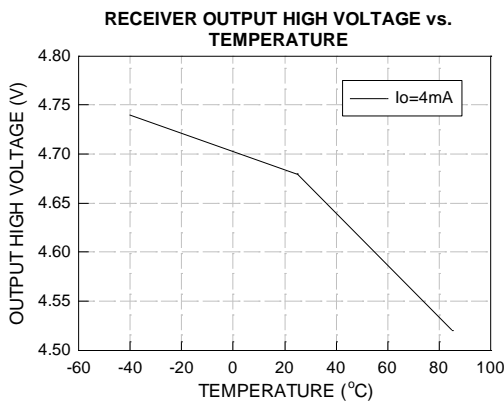
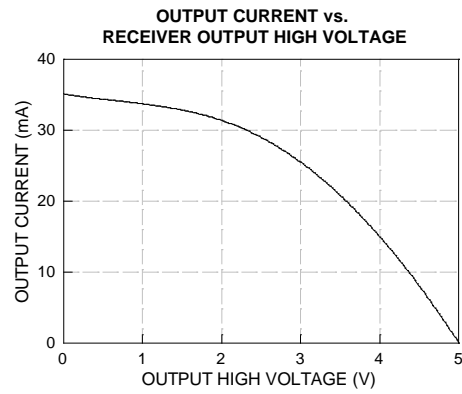
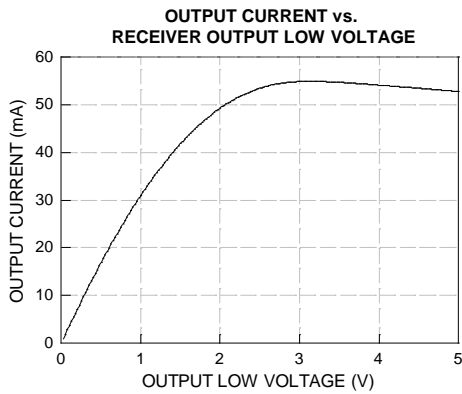



## PIN FUNCTION DESCRIPTION

Pin Number	Mnemonic	Function
1	RO	Receiver Output: When REB is low and if $(A - B) \geq -50\text{mV}$ , RO is high; if $(A - B) \leq -200\text{mV}$ , RO is low.
2	REB	Receiver Output Enable: REB is low to enable the Receiver; REB is high to disable the Receiver.
3	DE	Transmitter Output Enable: DE is high to enable the transmitter; DE is low to disable the transceiver.
4	DI	Transmitter Input: When DE is high, a low on DI forces A output low and B output high. Similarly, a high on DI forces A output high and B output low.
5	GND	Ground pin. Must be connected to 0V.
6	A	Non-inverting Receiver Input and Non-inverting Transmitter Output
7	B	Inverting Receiver Input and Inverting Transmitter Output
8	VCC	Power Supply Input 5V.

## FUNCTION TABLE

TRANSMITTING				
INPUTS			OUTPUTS	
REB	DE	DI	A	B
X	1	0	0	1
X	1	1	1	0
X	0	X	HIGH- Z	HIGH- Z

X= Don't care  
HIGH- Z= High impedance

RECEIVING			
INPUTS			OUTPUTS
REB	DE	A - B	RO
0	0	$\geq -0.05\text{V}$	1
0	0	$\leq -0.2\text{V}$	0
0	0	Open/Shorted	1
1	0	X	HIGH- Z

X= Don't care  
HIGH- Z= High impedance



## Detail Description

The AZRS3080E is a half-duplex RS-485 transceiver IC with IEC61000-4-2 contact  $\pm 15\text{kV}$  ESD protection for bus pins (A and B), which contains one transmitter and one receiver inside with 5V power supply. This device is fully compliant with the EIA/TIA-485 standard.

The AZRS3080E features the hot-swap glitch free design which guarantees the outputs of the transceiver in a high impedance state during the power-up period until the supply voltage has stabilized.

The AZRS3080E with whole chip ESD protected design for all of the I/O pins has robust ESD protection up to both HBM  $\pm 8\text{kV}$  and MM  $\pm 800\text{V}$ . Moreover, the latchup immunity of the AZRS3080E is up to  $\pm 400\text{mA}$  for all of the pins. For IC self discharge issue, the CDM protection level of the AZRS3080E is up to  $\pm 1\text{kV}$ .

## Transmitter

The design of the transmitter is a non-inverted translator that converts the single-ended TTL input signal to differential EIA/TIA-485 signal level. The transmitter of the AZRS3080E guarantees 10Mbps data rate communication. When the transmitter is active (DE= HIGH), the single-end TTL input signals of transmitter will be transported to differential output RS485 signals of the transmitter. Under the disable state (DE= LOW), the outputs of transmitter keep at high impedance state.

The differential output voltage VA-VB (VOD2) of the AZRS3080E is 2.3V with 54 ohm load under  $V_{cc} = 5.0\text{V}$ ,  $T = 25^\circ\text{C}$ .

## Receiver

The receiver of the AZRS3080E converts the differential EIA/TIA-485 signals to single-end output TTL signal when receiver is in active state (REB=LOW), which incorporates input filtering in addition to input hysteresis. The input filtering enhances the noise immunity under normal

operating condition. When the receiver is disable (REB=HIGH), the output of the receiver keeps in high impedance state no matter what the input of the receiver is.

## True Fail-Safe

In traditional design, the fail-safe function is implemented by two resistors on the PCB. One resistor is terminated pin A to VCC; the other is terminated pin B to GND to keep RO at high state when bus is idle, which is only the open fail-safe. The AZRS3080E guarantees a receiver output high when the receiver inputs are short, open or idle, that is true fail-safe. The threshold voltage of receiver input is between  $-50\text{mV}$  and  $-200\text{mV}$ . If the differential input voltage (A - B) of receiver is greater than or equal to  $-50\text{mV}$ , receiver output (RO) is logic-high. If (A - B) is less than or equal to  $-200\text{mV}$ , RO is logic-low. In the case of a terminated bus with all transmitters disabled, the receiver's differential input voltage (A - B) is 0V, so the RO is logic-high at that time.

## 1/8 Unit Load

The RS-485 standard defines both receiver inputs impedance are  $12\text{k}\Omega$  (1 unit load) and the maximum 32-unit loads on the bus. The AZRS3080E transceiver has a  $96\text{k}\Omega$  input impedance (1/8 unit load) of the receiver, allowing up to 256 or fewer devices to be connected in parallel on the RS485 bus.

## Transmitter Output Protection

The AZRS3080E has the current limitation function and the thermal shutdown protection in the transmitter. Firstly, the function of current limitation provides immediate protection against short circuits over the whole common-mode voltage range ( $-7\text{V}$  to  $+12\text{V}$ ). Secondly, the function of thermal shutdown protection forces the transmitter outputs into a high impedance state if the die temperature becomes excessive.

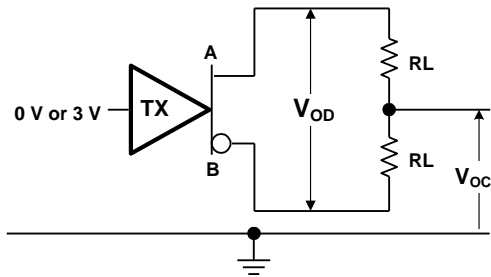

Fig.1 Transmitter DC test circuit

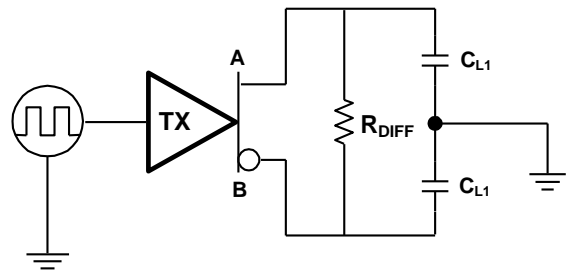

Fig.2 Transmitter timing test circuit

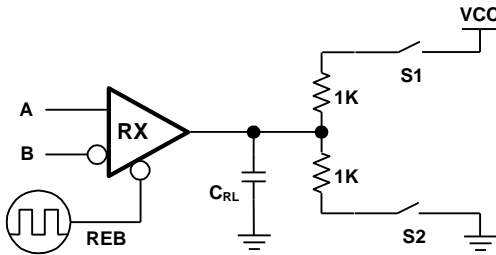

Fig.3 Receiver enable/disable timing test load

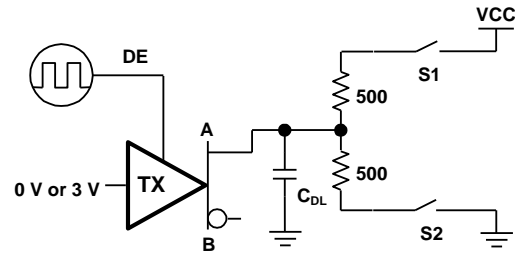

Fig.4 Transmitter enable/disable timing test load

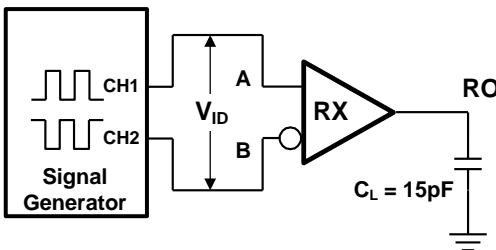

Fig.5 Receiver timing test circuit

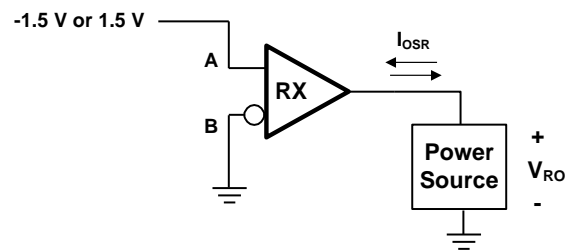

Fig.6 Receiver output short circuit

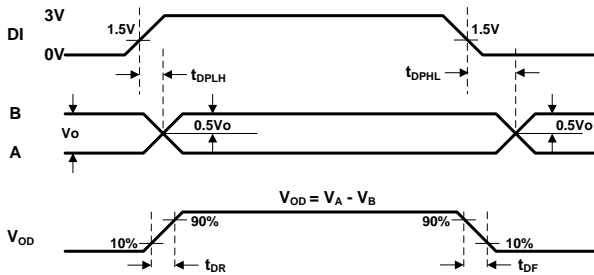

Fig.7 Transmitter Propagation Delays

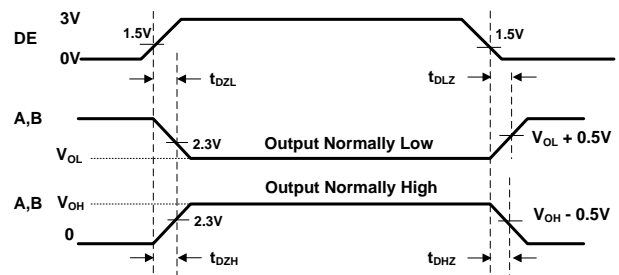

Fig.8 Transmitter Enable and Disable Times

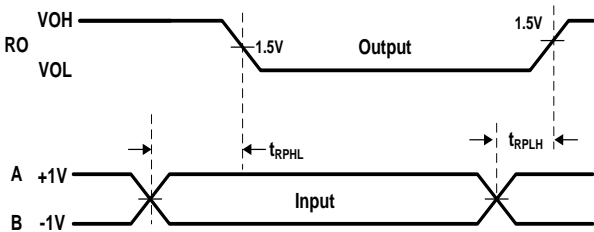

Fig.9 Receiver Propagation Delays

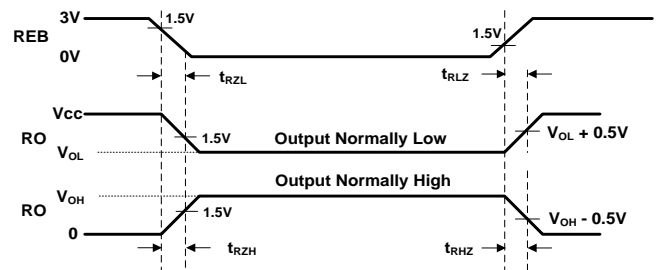
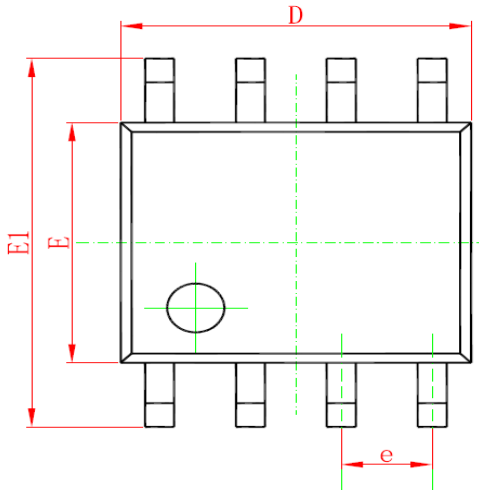

Fig.10 Receiver Enable and Disable Times



## Mechanical Details

**SOP-8L**  
**PACKAGE DIAGRAMS**  
**TOP VIEW**



**SIDE VIEW**

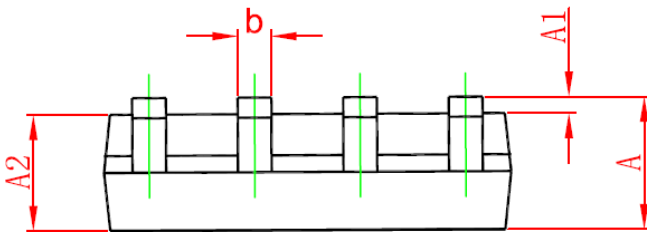

**END VIEW**

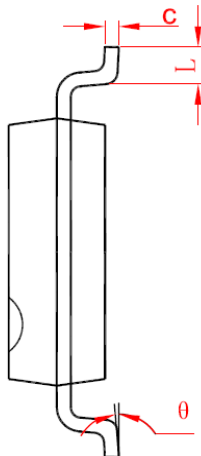

**PACKAGE DIMENSIONS**

Symbol	Millimeters		Inches	
	min	max	min	max
A	1.35	1.75	0.053	0.069
A1	0.10	0.25	0.004	0.010
A2	1.25	1.55	0.053	0.061
b	0.33	0.51	0.013	0.020
C	0.17	0.26	0.007	0.010
D	4.70	5.10	0.185	0.201
E	3.70	4.10	0.146	0.161
E1	5.80	6.20	0.228	0.244
e	1.27 BSC		0.05BSC	
L	0.40	1.27	0.016	0.050
Θ	0	8	0	8

## MARKING CODE

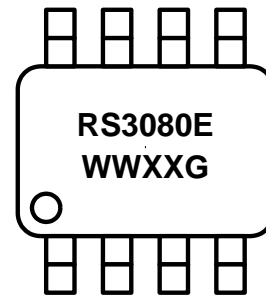

RS3080E = Device Code

WW = Date Code

XX = Control Code

G = Green Part Indication

Part Number	Marking Code
AZRS3080E.RDG	RS3080E WWXXG





## Ordering Information

PN#	Material	Type	Reel size	MOQ/interal box	MOQ/carton
AZRS3080E.RDG	Green	T/R	13 inch	1 reel=2,500/box	5 boxes=12,500/carton

## Revision History

Revision	Modification Description
Revision 2016/09/05	Formal Release.