

# MOSFET – P-Channel, POWERTRENCH®

60 V

## FDD5614P

### General Description

This 60 V P-Channel MOSFET uses onsemi's high voltage POWERTRENCH process. It has been optimized for power management applications.

### Features

- -15 A, -60 V
  - ♦  $R_{DS(ON)} = 100\text{ m}\Omega$  at  $V_{GS} = -10\text{ V}$
  - ♦  $R_{DS(ON)} = 130\text{ m}\Omega$  at  $V_{GS} = -4.5\text{ V}$
- Fast Switching Speed
- High Performance Trench Technology for Extremely Low  $R_{DS(ON)}$
- High Power and Current Handling Capability
- This is a Pb-Free Device

### Applications

- DC/DC Converter
- Power Management
- Load Switch

### ABSOLUTE MAXIMUM RATINGS ( $T_A = 25^\circ\text{C}$ unless otherwise noted)

Symbol	Parameter	Ratings	Unit
$V_{DS}$	Drain-Source Voltage	-60	V
$V_{GS}$	Gate-Source Voltage	$\pm 20$	V
$I_D$	Drain Current - Continuous (Note 3) - Pulsed (Note 1a)	-15 -45	A
$P_D$	Power Dissipation for Single Operation (Note 1) (Note 1a) (Note 1b)	42 3.8 1.6	W
$T_J, T_{STG}$	Operating and Storage Junction Temperature Range	-55 to +175	$^\circ\text{C}$

Stresses exceeding those listed in the Maximum Ratings table may damage the device. If any of these limits are exceeded, device functionality should not be assumed, damage may occur and reliability may be affected.

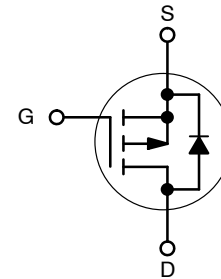

P-Channel MOSFET

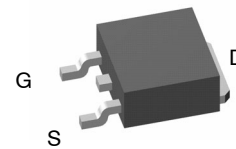

DPAK3 (TO-252 3 LD)  
CASE 369AS

### MARKING DIAGRAM

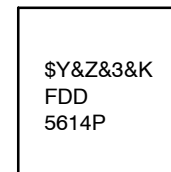

FDD5614P = Specific Device Code  
 \$Y = onsemi Logo  
 &Z = Assembly Plant Code  
 &3 = 3-Digit Date Code  
 &K = 2-Digits Lot Run Traceability Code

### ORDERING INFORMATION

Device	Package	Shipping†
FDD5614P	TO-252-3 (Pb-Free)	2500 / Tape & Reel

†For information on tape and reel specifications, including part orientation and tape sizes, please refer to our Tape and Reel Packaging Specification Brochure, BRD8011/D.

# FDD5614P

## THERMAL CHARACTERISTICS

Symbol	Parameter	Ratings	Unit
$R_{\theta JC}$	Thermal Resistance, Junction to Case (Note 1)	3.5	$^{\circ}\text{C}/\text{W}$
$R_{\theta JA}$	Thermal Resistance, Junction to Ambient (Note 1a)	40	$^{\circ}\text{C}/\text{W}$
$R_{\theta JA}$	Thermal Resistance, Junction to Ambient (Note 1b)	96	$^{\circ}\text{C}/\text{W}$

## ELECTRICAL CHARACTERISTICS ( $T_A = 25^{\circ}\text{C}$ unless otherwise noted)

Symbol	Parameter	Condition	Min	Typ	Max	Unit
--------	-----------	-----------	-----	-----	-----	------

### DRAIN-SOURCE AVALANCHE RATINGS (Note 1)

$W_{DSS}$	Single Pulse Drain-Source Avalanche Energy	$V_{DD} = -30\text{ V}, I_D = -4.5\text{ A}$	-	-	90	mJ
$I_{AR}$	Maximum Drain-Source Avalanche Current		-	-	-4.5	A

### OFF CHARACTERISTICS

$B_{VDSS}$	Drain-Source Breakdown Voltage	$V_{GS} = 0\text{ V}, I_D = -250\ \mu\text{A}$	-60	-	-	V
$\frac{\Delta V_{DSS}}{\Delta T_J}$	Breakdown Voltage Temperature Coefficient	$I_D = -250\ \mu\text{A}$ , Referenced to $25^{\circ}\text{C}$	-	-49	-	$\text{mV}/^{\circ}\text{C}$
$I_{DSS}$	Zero Gate Voltage Drain Current	$V_{DS} = -48\text{ V}, V_{GS} = 0\text{ V}$	-	-	-1	$\mu\text{A}$
$I_{GSSF}$	Gate-Body Leakage, Forward	$V_{GS} = 20\text{ V}, V_{DS} = 0\text{ V}$	-	-	100	nA
$I_{GSSR}$	Gate-Body Leakage, Reverse	$V_{GS} = -20\text{ V}, V_{DS} = 0\text{ V}$	-	-	-100	nA

### ON CHARACTERISTICS (Note 2)

$V_{GS(th)}$	Gate to Threshold Voltage	$V_{DS} = V_{GS}, I_D = -250\ \mu\text{A}$	-1	-1.6	-3	V
$\frac{\Delta V_{GS(th)}}{\Delta T_J}$	Gate Threshold Voltage Temperature Coefficient	$I_D = -250\ \mu\text{A}$ , Referenced to $25^{\circ}\text{C}$	-	4	-	$\text{mV}/^{\circ}\text{C}$
$R_{DS(on)}$	Static Drain-Source On-Resistance	$V_{GS} = -10\text{ V}, I_D = -4.5\text{ A}$	-	76	100	m $\Omega$
		$V_{GS} = -4.5\text{ V}, I_D = -3.9\text{ A}$	-	99	130	
		$V_{GS} = -10\text{ V}, I_D = -4.5\text{ A}, T_J = 125^{\circ}\text{C}$	-	137	185	
$I_{D(on)}$	On-State Drain Current	$V_{GS} = -10\text{ V}, V_{DS} = -5\text{ V}$	-20	-	-	A
$g_{FS}$	Forward Transconductance	$V_{DS} = -5\text{ V}, I_D = -3\text{ A}$	-	8	-	S

### DYNAMIC CHARACTERISTICS

$C_{iss}$	Input Capacitance	$V_{DS} = -30\text{ V}, V_{GS} = 0\text{ V}, f = 1\text{ MHz}$	-	759	-	pF
$C_{oss}$	Output Capacitance		-	90	-	pF
$C_{rss}$	Reverse Transfer Capacitance		-	39	-	pF

### SWITCHING CHARACTERISTICS

$t_{d(on)}$	Turn-On Delay Time	$V_{DD} = -30\text{ V}, I_D = -1\text{ A}, V_{GS} = -10\text{ V}, R_{GEN} = 6\ \Omega$	-	7	14	ns
$t_r$	Turn-On Rise Time		-	10	20	ns
$t_{d(off)}$	Turn-Off Delay Time		-	19	34	ns
$t_f$	Turn-Off Fall Time		-	12	22	ns
$Q_g$	Total Gate Charge	$V_{DS} = -30\text{ V}, I_D = -4.5\text{ A}, V_{GS} = -10\text{ V}$	-	15	24	nC
$Q_{gs}$	Gate-Source Charge		-	2.5	-	nC
$Q_{gd}$	Gate-Drain Charge		-	3.0	-	nC

# FDD5614P

## ELECTRICAL CHARACTERISTICS ( $T_A = 25^\circ\text{C}$ unless otherwise noted) (continued)

Symbol	Parameter	Condition	Min	Typ	Max	Unit
--------	-----------	-----------	-----	-----	-----	------

### DRAIN-SOURCE AVELANCHE RATINGS

$I_S$	Maximum Continuous Drain-Source Diode Forward Current		-	-	-3.2	A
$V_{SD}$	Drain-Source Diode Forward Voltage	$V_{GS} = 0\text{ V}, I_S = -3.2\text{ A}$ (Note 2)	-	-0.8	-1.2	V

Product parametric performance is indicated in the Electrical Characteristics for the listed test conditions, unless otherwise noted. Product performance may not be indicated by the Electrical Characteristics if operated under different conditions.

- $R_{\theta JA}$  is the sum of the junction-to-case and case-to-ambient thermal resistance where the case thermal reference is defined as the solder mounting surface of the drain pins.  $R_{\theta JC}$  is guaranteed by design while  $R_{\theta CA}$  is determined by the user's board design.



- a)  $R_{\theta JA} = 40^\circ\text{C/W}$  when mounted on a  $1\text{ in}^2$  pad of 2 oz copper.



- b)  $R_{\theta JA} = 96^\circ\text{C/W}$  when mounted on a minimum pad.

- Pulse Test: Pulse Width < 300  $\mu\text{s}$ , Duty Cycle < 2.0%.

- Maximum current is calculated as: 
$$\sqrt{\frac{P_D}{R_{DS(ON)}}}$$

where  $P_D$  is maximum power dissipation at  $T_C = 25^\circ\text{C}$  and  $R_{DS(on)}$  is at  $T_{J(max)}$  and  $V_{GS} = 10\text{ V}$ . Package current limitation is 21 A.

TYPICAL CHARACTERISTICS

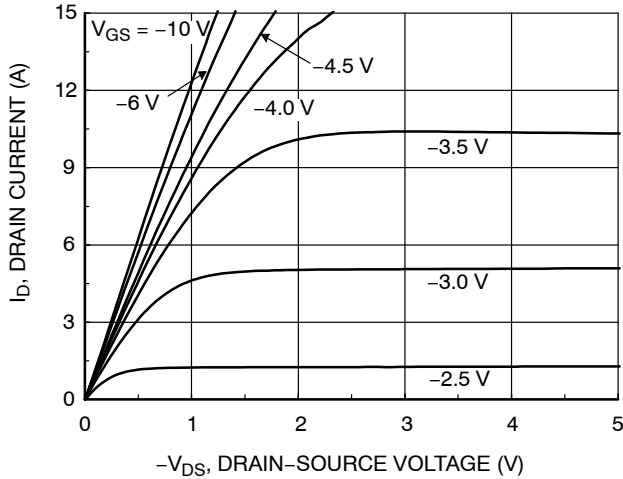

Figure 1. On-Region Characteristics

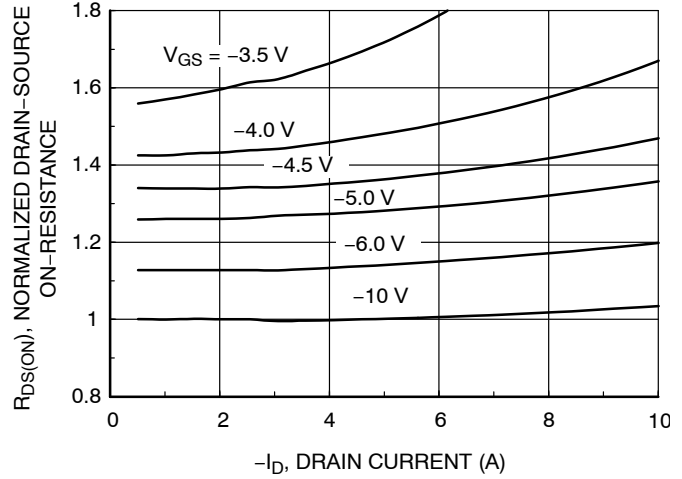

Figure 2. On-Resistance Variation with Drain Current and Gate Voltage

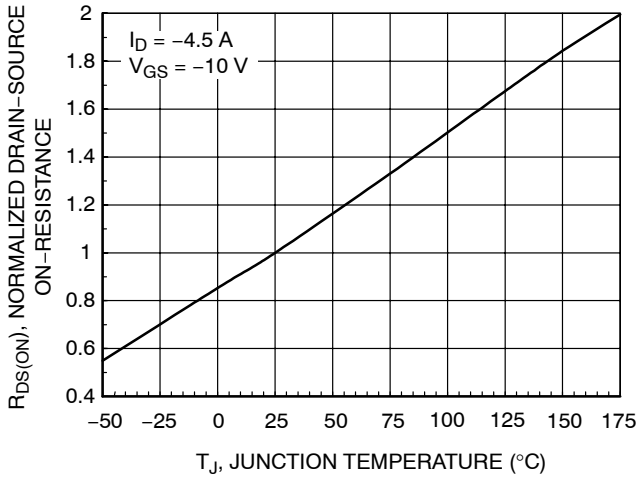

Figure 3. On-Resistance Variation with Temperature

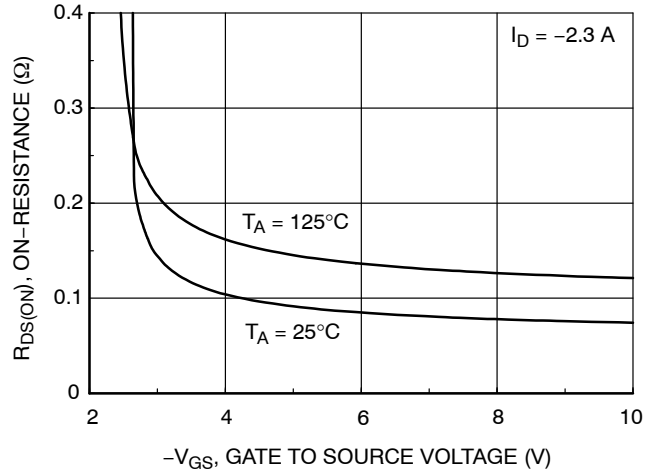

Figure 4. On-Resistance Variation with Gate-to-Source Voltage

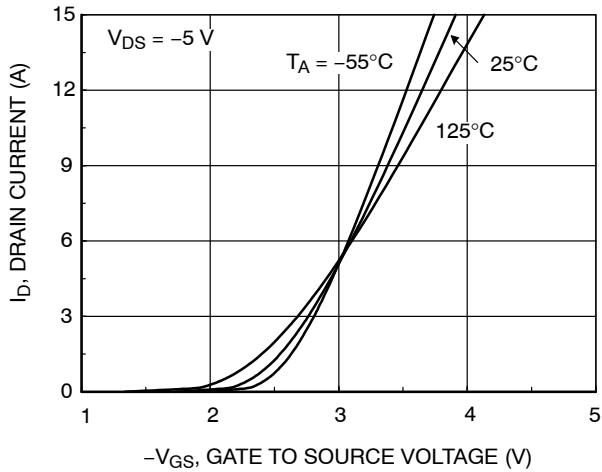

Figure 5. Transfer Characteristics

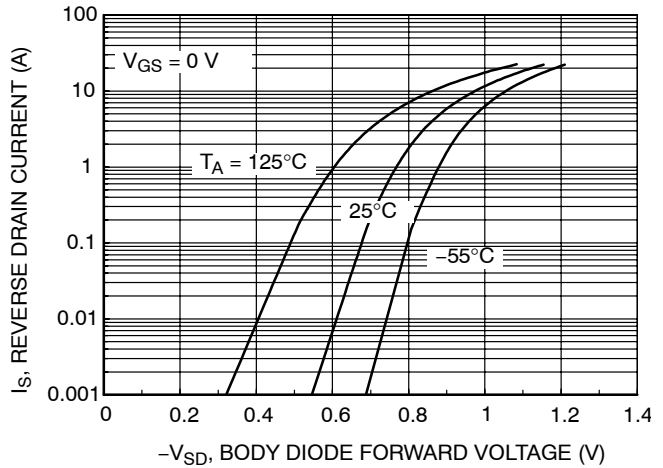

Figure 6. Body Diode Forward Voltage Variation with Source Current and Temperature

TYPICAL CHARACTERISTICS (continued)

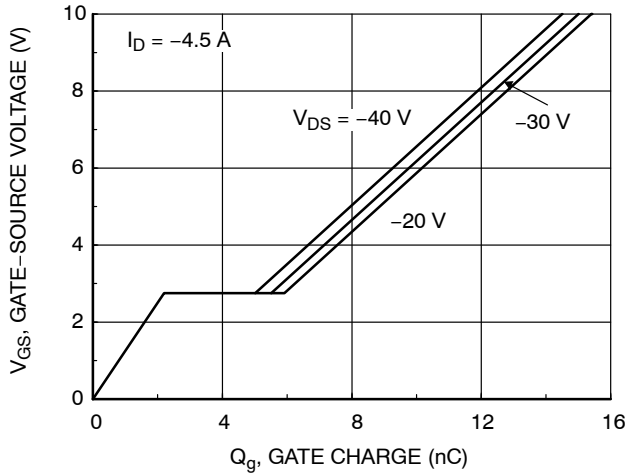

Figure 7. Gate Charge Characteristics

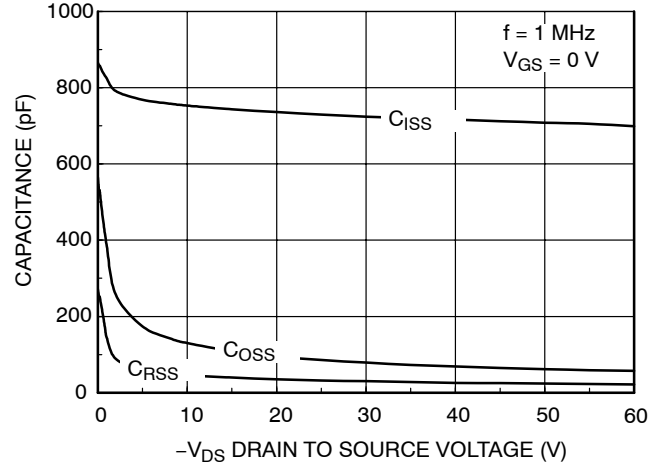

Figure 8. Capacitance Characteristics

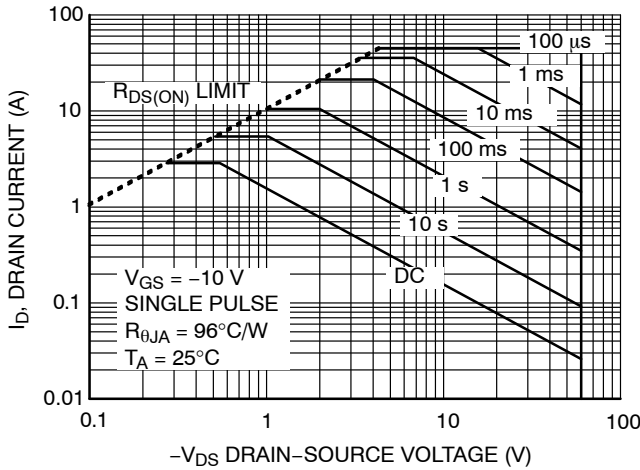

Figure 9. Maximum Safe Operating Area

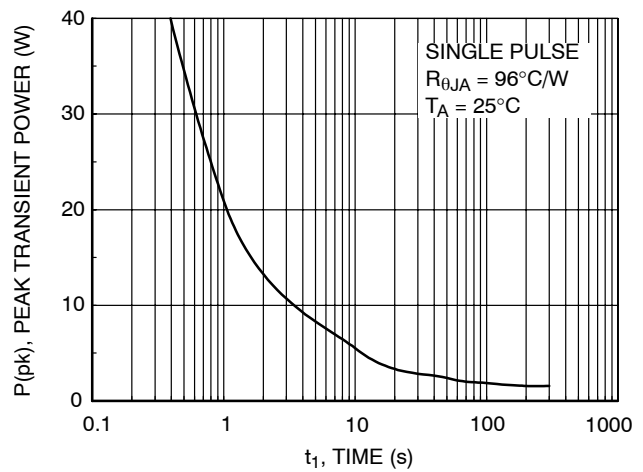
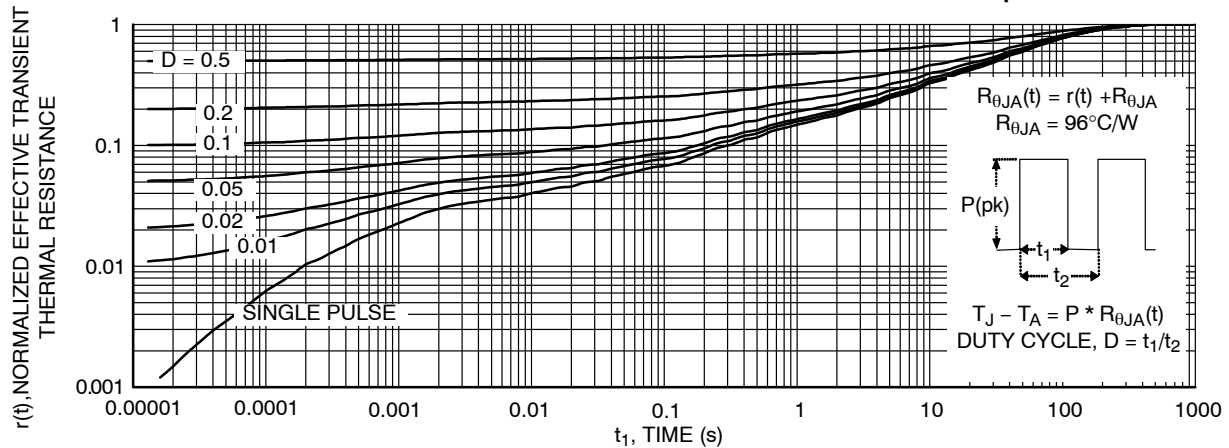

Figure 10. Single Pulse Maximum Power Dissipation



Thermal characterization performed using the conditions described in Note 1b. Transient thermal response will change depending on the circuit board design.

Figure 11. Transient Thermal Response Curve

# MECHANICAL CASE OUTLINE PACKAGE DIMENSIONS

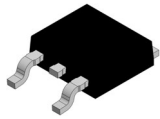

## DPAK3 (TO-252 3 LD) CASE 369AS ISSUE A

DATE 28 SEP 2022

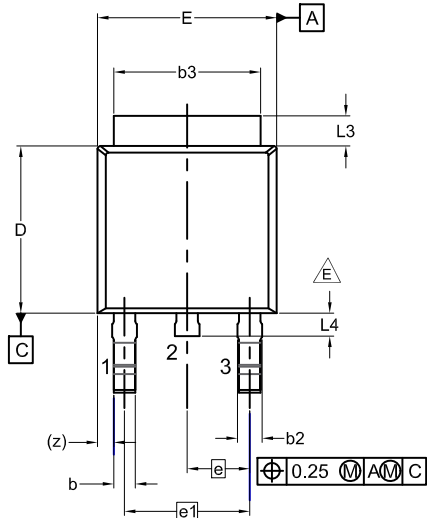

- NOTES: UNLESS OTHERWISE SPECIFIED  
 A) THIS PACKAGE CONFORMS TO JEDEC, TO-252, ISSUE C, VARIATION AA.  
 B) ALL DIMENSIONS ARE IN MILLIMETERS.  
 C) DIMENSIONING AND TOLERANCING PER ASME Y14.5M-2009.  
 D) SUPPLIER DEPENDENT MOLD LOCKING HOLES OR CHAMFERED CORNERS OR EDGE PROTRUSION.  
 E) FOR DIODE PRODUCTS, L4 IS 0.25 MM MAX.  
 F) DIMENSIONS ARE EXCLUSIVE OF BURRS, MOLD FLASH AND TIE BAR EXTRUSIONS.  
 G) LAND PATTERN RECOMMENDATION IS BASED ON IPC7351A STD TO228P991X239-3N.

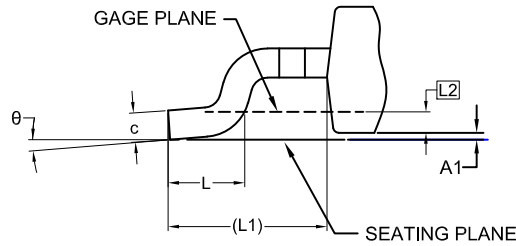

**DETAIL A**  
(ROTATED -90°)  
SCALE: 12X

DIM	MILLIMETERS		
	MIN.	NOM.	MAX.
A	2.18	2.29	2.39
A1	0.00	-	0.127
b	0.64	0.77	0.89
b2	0.76	0.95	1.14
b3	5.21	5.34	5.46
c	0.45	0.53	0.61
c2	0.45	0.52	0.58
D	5.97	6.10	6.22
D1	5.21	-	-
E	6.35	6.54	6.73
E1	4.32	-	-
e	2.286 BSC		
e1	4.572 BSC		
H	9.40	9.91	10.41
L	1.40	1.59	1.78
L1	2.90 REF		
L2	0.51 BSC		
L3	0.89	1.08	1.27
L4	-	-	1.02
θ	0°	--	10°

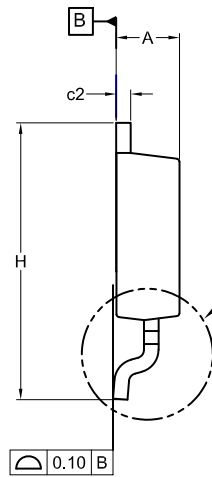
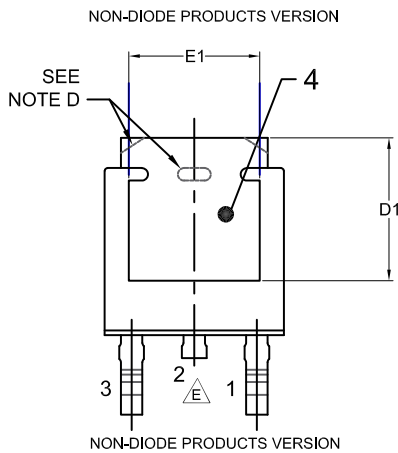

### GENERIC MARKING DIAGRAM\*



- XXXX = Specific Device Code
- A = Assembly Location
- Y = Year
- WW = Work Week
- ZZ = Assembly Lot Code

\*This information is generic. Please refer to device data sheet for actual part marking. Pb-free indicator, "G" or microdot "•", may or may not be present. Some products may not follow the Generic Marking.

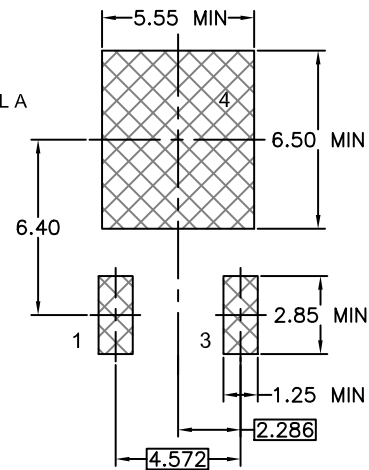

### LAND PATTERN RECOMMENDATION

\*FOR ADDITIONAL INFORMATION ON OUR PB-FREE STRATEGY AND SOLDERING DETAILS, PLEASE DOWNLOAD THE ON SEMICONDUCTOR SOLDERING AND MOUNTING TECHNIQUES REFERENCE MANUAL, SOLDERRM/D.

<b>DOCUMENT NUMBER:</b>	<b>98AON13810G</b>	Electronic versions are uncontrolled except when accessed directly from the Document Repository. Printed versions are uncontrolled except when stamped "CONTROLLED COPY" in red.
<b>DESCRIPTION:</b>	<b>DPAK3 (TO-252 3 LD)</b>	<b>PAGE 1 OF 1</b>

onsemi and ONSEMI are trademarks of Semiconductor Components Industries, LLC dba onsemi or its subsidiaries in the United States and/or other countries. onsemi reserves the right to make changes without further notice to any products herein. onsemi makes no warranty, representation or guarantee regarding the suitability of its products for any particular purpose, nor does onsemi assume any liability arising out of the application or use of any product or circuit, and specifically disclaims any and all liability, including without limitation special, consequential or incidental damages. onsemi does not convey any license under its patent rights nor the rights of others.

**onsemi**, **Onsemi**, and other names, marks, and brands are registered and/or common law trademarks of Semiconductor Components Industries, LLC dba "**onsemi**" or its affiliates and/or subsidiaries in the United States and/or other countries. **onsemi** owns the rights to a number of patents, trademarks, copyrights, trade secrets, and other intellectual property. A listing of **onsemi**'s product/patent coverage may be accessed at [www.onsemi.com/site/pdf/Patent-Marking.pdf](http://www.onsemi.com/site/pdf/Patent-Marking.pdf). **onsemi** reserves the right to make changes at any time to any products or information herein, without notice. The information herein is provided "as-is" and **onsemi** makes no warranty, representation or guarantee regarding the accuracy of the information, product features, availability, functionality, or suitability of its products for any particular purpose, nor does **onsemi** assume any liability arising out of the application or use of any product or circuit, and specifically disclaims any and all liability, including without limitation special, consequential or incidental damages. Buyer is responsible for its products and applications using **onsemi** products, including compliance with all laws, regulations and safety requirements or standards, regardless of any support or applications information provided by **onsemi**. "Typical" parameters which may be provided in **onsemi** data sheets and/or specifications can and do vary in different applications and actual performance may vary over time. All operating parameters, including "Typicals" must be validated for each customer application by customer's technical experts. **onsemi** does not convey any license under any of its intellectual property rights nor the rights of others. **onsemi** products are not designed, intended, or authorized for use as a critical component in life support systems or any FDA Class 3 medical devices or medical devices with a same or similar classification in a foreign jurisdiction or any devices intended for implantation in the human body. Should Buyer purchase or use **onsemi** products for any such unintended or unauthorized application, Buyer shall indemnify and hold **onsemi** and its officers, employees, subsidiaries, affiliates, and distributors harmless against all claims, costs, damages, and expenses, and reasonable attorney fees arising out of, directly or indirectly, any claim of personal injury or death associated with such unintended or unauthorized use, even if such claim alleges that **onsemi** was negligent regarding the design or manufacture of the part. **onsemi** is an Equal Opportunity/Affirmative Action Employer. This literature is subject to all applicable copyright laws and is not for resale in any manner.

## ADDITIONAL INFORMATION

### TECHNICAL PUBLICATIONS:

Technical Library: [www.onsemi.com/design/resources/technical-documentation](http://www.onsemi.com/design/resources/technical-documentation)  
onsemi Website: [www.onsemi.com](http://www.onsemi.com)

### ONLINE SUPPORT: [www.onsemi.com/support](http://www.onsemi.com/support)

For additional information, please contact your local Sales Representative at [www.onsemi.com/support/sales](http://www.onsemi.com/support/sales)