

# C4520C0G3F270K160KA

TDK Item Description : C4520C0G3F270KT\*\*\*\*



## Application & Main Feature

Commercial Grade ( High Voltage (1000V and over) )

## Series

C4520 [EIA CC1808]

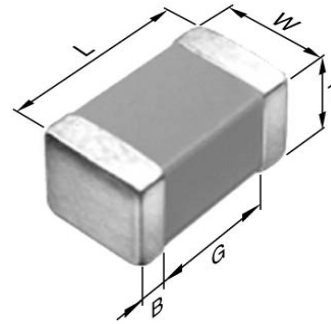

## Dimensions

L 4.50mm +/-0.4mm  
 W 2.00mm +/-0.2mm  
 T 1.60mm +/-0.2mm  
 B 0.20mm Min.  
 G

## Temperature Characteristic

C0G (-55 to 125 degC 0+/-30ppm/degC)

## Rated Voltage

3F (3000Vdc)

## Capacitance

27pF

## Capacitance Tolerance

K (+/-10%)

## Q Factor

940 Min.

## Insulation Resistance

10Gohm Min.

## AEC-Q200

Not Applicable

**|Z|, ESR vs. Freq. Characteristics**

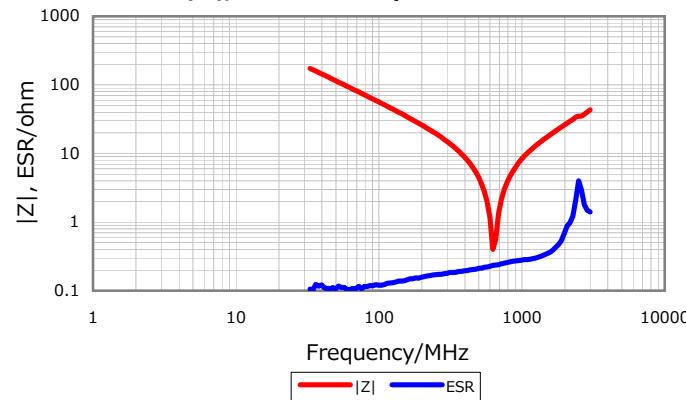

**DC Bias Characteristic**



**Cap. vs. Freq. Characteristic**

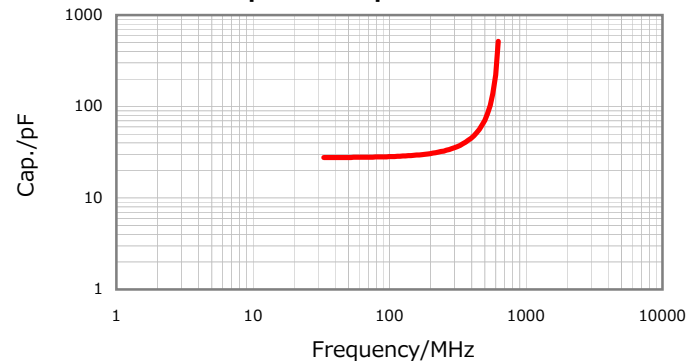

**Temperature Characteristics**

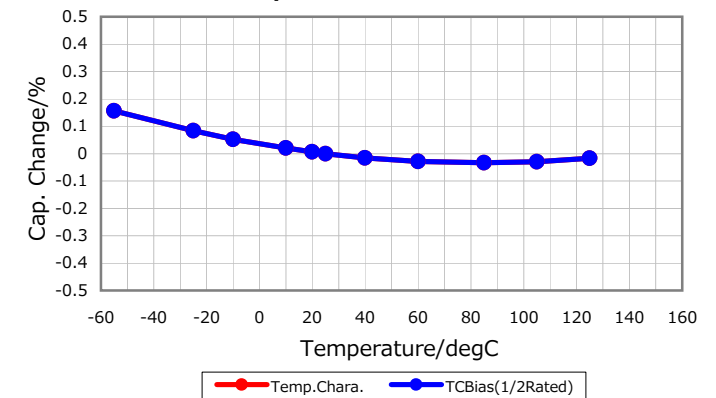

Characterization Sheet ( Multilayer Ceramic Chip Capacitors )



All specifications are subject to change without notice.

January 4, 2016