

PART NUMBER		SSL-LXA228SUGCTR31	REV	C
REV	E.C.N. NUMBER AND REVISION COMMENTS			DATE
A	E.C.N #11148.			11.15.06
B	E.C.N #11508.			06.13.08
C	ECN-Lumex201700060			09.20.17

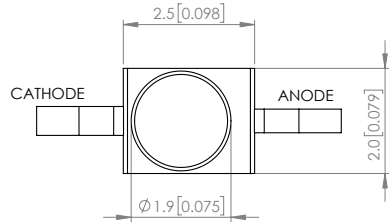

POLARITY

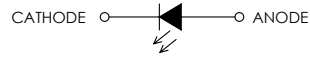

ELECTRO-OPTICAL CHARACTERISTIC TA=25°C

PARAMETER	MIN	TYP	MAX	UNITS	TEST COND
PEAK WAVELENGTH	-	575	-	nm	If=20mA
FORWARD VOLTAGE	-	2.0	2.4	Vf	If=20mA
REVERSE VOLTAGE	-	-	5	Vr	Ir=10uA
LUMINOUS INTENSITY	-	200	-	mcd	If=20mA
VIEWING ANGLE	-	25	-	2x theta 1/2	-
EMITTED COLOR	GREEN				
EPOXY LENS FINISH	WATER CLEAR				

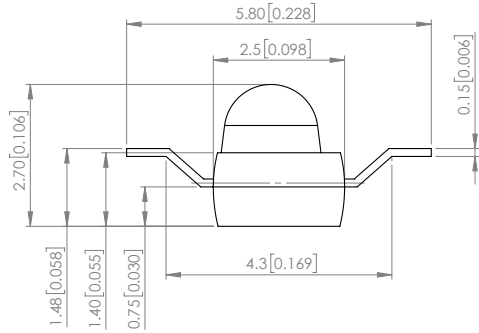

RECOMMENDED SOLDER PAD LAYOUT

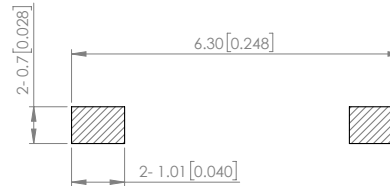
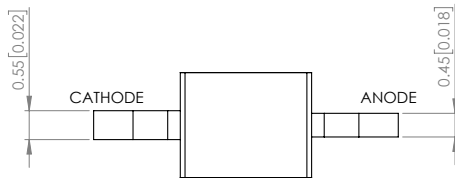

ABSOLUTE MAXIMUM RATINGS TA=25°C

PARAMETER	MAX	UNITS
PEAK FORWARD CURRENT*	160	mA
FORWARD CURRENT	25	mA
POWER DISIPATION	60	mW
ELECTROSTATIC DISCHARGE	1000	V
STORAGE TEMPERATURE	-40 TO +90	°C
OPERATING TEMPERATURE	-40 TO +85	°C
SOLDERING TEMPERATURE**	3 SEC. MAX. @260	°C

*t<10us

** 2.0mm FROM BODY.

NOTE:

1. RoHS COMPLIANT.
2. COMPLIANCE WITH EU REACH.
3. COMPLIANCE Halogen FREE.
(Br<900 ppm, Cl<900ppm, Br+Cl<1500ppm)

MOISTURE SENSITIVE DEVICE
PER JEDEC LEVEL 4 STANDARDS

*UNLESS OTHERWISE SPECIFIED TOLERANCES PER DECIMAL PRECISION ARE: X=±1 (±0.039), X.X=±0.5 (±0.020), X.XX=±0.25 (±0.010), X.XXX=±0.127 (±0.005). LEAD SIZE=±0.05 (±0.002), LEAD LENGTH=±0.75 (±0.030), MIN= ^{0.00}/_{0.00} DECIMAL PRECISION MAX.= ^{0.00}/_{0.00} DECIMAL PRECISION



425 N. GARY AVE.
CAROL STREAM, IL 60188
PHONE : 800-278-5666
FAX : 630-315-2150
WEB : WWW.LUMEX.COM

2(L)*5.8(W)*2.7(H)mm, AXIAL LED, AlGaInP 575nm GREEN, WATER CLEAR LENS, TAPE & REEL.

THE SPECIFICATIONS MAY CHANGE AT ANY TIME WITHOUT NOTICE DUE TO NEW MATERIALS OR PRODUCT IMPROVEMENT.

CONFIDENTIAL INFORMATION
THE INFORMATION CONTAINED IN THIS DOCUMENT IS THE PROPERTY OF LUMEX INC. EXCEPT AS SPECIFICALLY AUTHORIZED IN WRITING BY LUMEX INC., THE HOLDER OF THIS DOCUMENT SHALL KEEP ALL INFORMATION CONTAINED HEREIN CONFIDENTIAL AND SHALL PROTECT SAME IN WHOLE OR IN PART FROM DISCLOSURE AND DISSEMINATION TO ALL THIRD PARTIES.

DATE : 2017.09.20	DRAWN BY : C.C.
PAGE : 1 OF 2	CHKD BY : G.Y.
SCALE : NTF	APRVD BY : E.C.
UNIT : mm [INCH]	

PROFILE

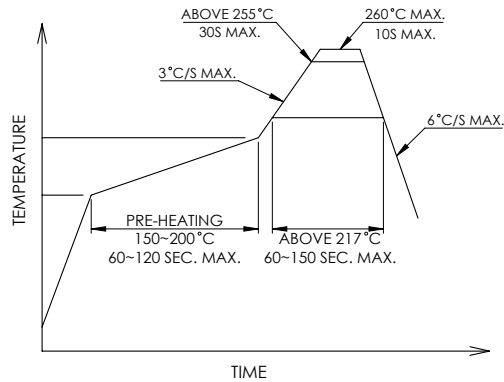

CARRIER TAPE DIMENSION

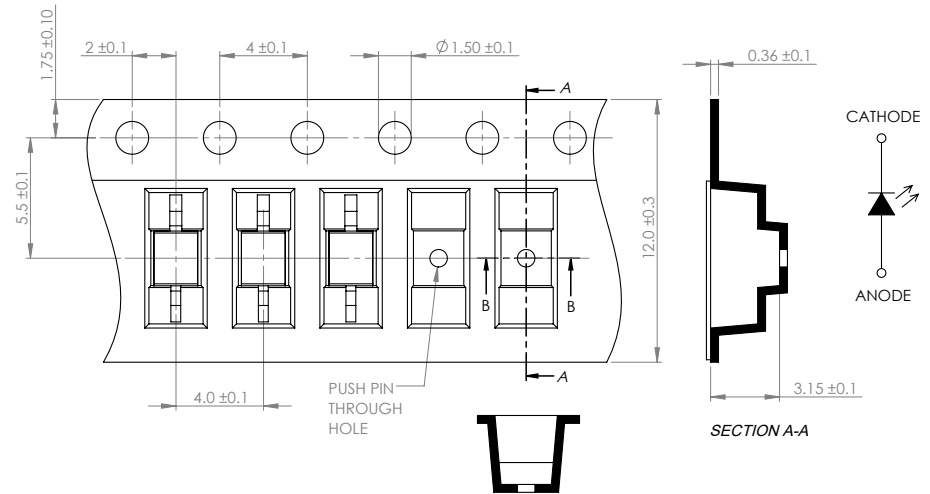

NOTE:
1. 1,000 PCS PER REEL.

*UNLESS OTHERWISE SPECIFIED TOLERANCES PER DECIMAL PRECISION ARE: X=±1 (±0.039), X.X=±0.5 (±0.020), X.XX=±0.25 (±0.010), X.XXX=±0.127 (±0.005). LEAD SIZE=±0.05 (±0.002), LEAD LENGTH=±0.75 (±0.030). MIN= ^{0.00}/_{0.00} DECIMAL PRECISION MAX= ^{0.00}/_{0.00} DECIMAL PRECISION



425 N. GARY AVE.
CAROL STREAM, IL 60188
PHONE : 800-278-5666
FAX : 630-315-2150
WEB : WWW.LUMEX.COM

2(L)*5.8(W)*2.7(H)mm, AXIAL LED, AlGaInP 575nm GREEN, WATER CLEAR LENS, TAPE & REEL.
THE SPECIFICATIONS MAY CHANGE AT ANY TIME WITHOUT NOTICE DUE TO NEW MATERIALS OR PRODUCT IMPROVEMENT.
CONFIDENTIAL INFORMATION
THE INFORMATION CONTAINED IN THIS DOCUMENT IS THE PROPERTY OF LUMEX INC. EXCEPT AS SPECIFICALLY AUTHORIZED IN WRITING BY LUMEX INC., THE HOLDER OF THIS DOCUMENT SHALL KEEP ALL INFORMATION CONTAINED HEREIN CONFIDENTIAL AND SHALL PROTECT SAME IN WHOLE OR IN PART FROM DISCLOSURE AND DISSEMINATION TO ALL THIRD PARTIES.

DATE : 2017.09.20	DRAWN BY : C.C.
PAGE : 2 OF 2	CHKD BY : G.Y.
SCALE : NTF	APRVD BY : E.C.
UNIT : mm [INCH]	