





A Product Line of  
Diodes Incorporated



# SPECIFICATION FOR APPROVAL

CUSTOMER	
NOMINAL FREQUENCY	<b>25.000000 MHz</b>
PRODUCT TYPE	<b>TYPE FP 7x5 SEAM SEALED CRYSTAL</b>
PART NUMBER	<b>FP2500054</b>
CUSTOMER P/N	
ISSUE DATE	<b>March 1, 2018</b>
VERSION	<b>C</b>

APPROVED	PREPARED	QA
		

## Diodes Incorporated

No.2, Ziqiang 5th Rd., Zhongli Industrial Park,  
Zhongli Dist., Taoyuan City 32063, Taiwan (R.O.C.)  
TEL:886-3-451-8888  
FAX:886-3-461-3865  
<https://www.diodes.com>

- \*Pb-free
- \*RoHS Compliant
- \*HF-Halogen Free
- \*REACH Compliant

# TYPE FP 7x5 SEAM SEALED CRYSTAL

**FP2500054**

VER.C 01-MAR-18

## ELECTRICAL SPECIFICATIONS

Item	Symbol	Specifications	Units	Notes
Nominal Frequency	Fn	25.000000	MHz	
Mode of Oscillation	MO	AT Cut-Fundamental		
Calibration Load Capacitance	CL	18	pF	
Calibration Tolerance	FL	$\pm 30$	ppm	at 25°C $\pm 3^{\circ}\text{C}$
Operating Temperature Range	TR	-40 to +85	°C	
Frequency Stability(Frequency Deviation over the Operating Temperature Range)	F/T	$\pm 30$	ppm	Reference to the Frequency at 25°C
Operating Drive Level		10	$\mu\text{W}$	
Maximum Drive Level		500	$\mu\text{W}$	
Equivalent Series Resistance	ESR	30	$\Omega$	Max.
Shunt Capacitance	C0	7	pF	Max.
Aging at 25°C		$\pm 5$	ppm	Max, 1st year
Storage Temperature		-55 to +125	°C	
Insulation Resistance		500	M $\Omega$	Min

\*\* This product doesn't include harmful substance that stipulated by SONY SS-00259 Level 1 and S-AT2-001 Level 1 standard. RoHS Compliant (Pb - Free).

# TYPE FP 7x5 SEAM SEALED CRYSTAL

**FP2500054**

VER.C 01-MAR-18

## RELIABILITY SPECIFICATIONS

### MECHANICAL AND ENVIRONMENTAL RATINGS:

- a) FINE LEAK TEST: JESD22-A109 (Condition 1A)
- b) GROSS LEAK TEST: JESD22-A109 (Condition C)
- c) MOISTURE RESISTANCE: JESD22-A113
- d) SHOCK: JESD22-B104 (Condition B)
- e) SOLDERABILITY : (RoHS version): J-STD-002
- f) VIBRATION: JESD22-B103
- g) SOLVENT RESISTANCE: JESD22-B107
- h) RESISTANCE TO SOLDERING HEAT (RoHS version): J-STD-020D Table 5.2 Pb free devices (3 cycles max)

## SUGGESTED IR REFLOW PROFILE

\*As per IPC-JEDEC J-STD-020D



Note:

	Stage	Temperature	Time
A	Preheat	150~200°C	60~120 Sec
B	Primary Heat	217°C	60~150 Sec
C	Peak	260°C	10 Sec

# TYPE FP 7x5 SEAM SEALED CRYSTAL

**FP2500054**

VER.C 01-MAR-18

## MARKING

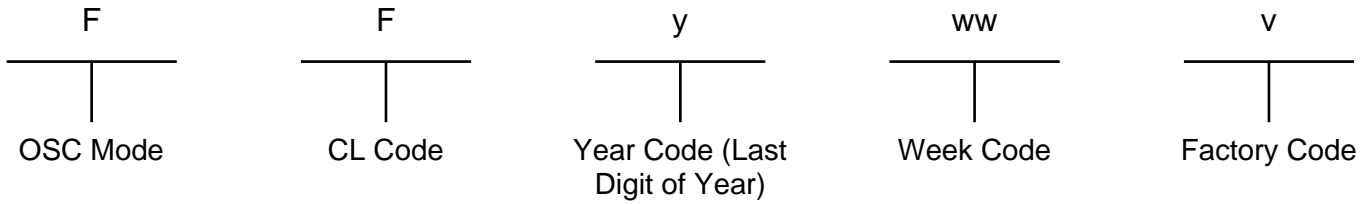
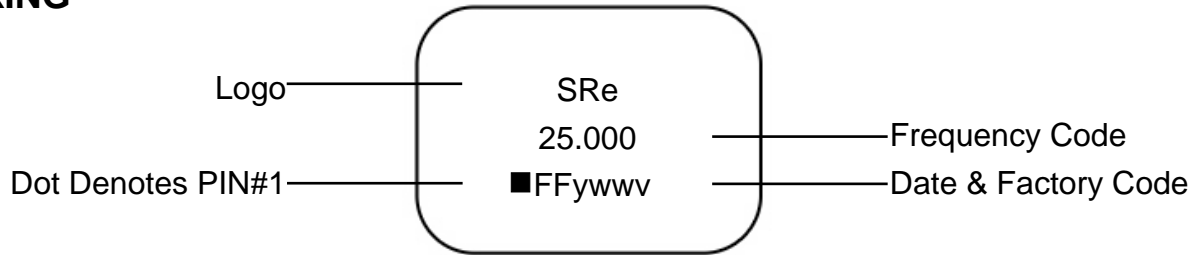

## MECHANICAL DRAWINGS ( Scale: None. Dimensions are in mm.)

### Recommended Land Pattern

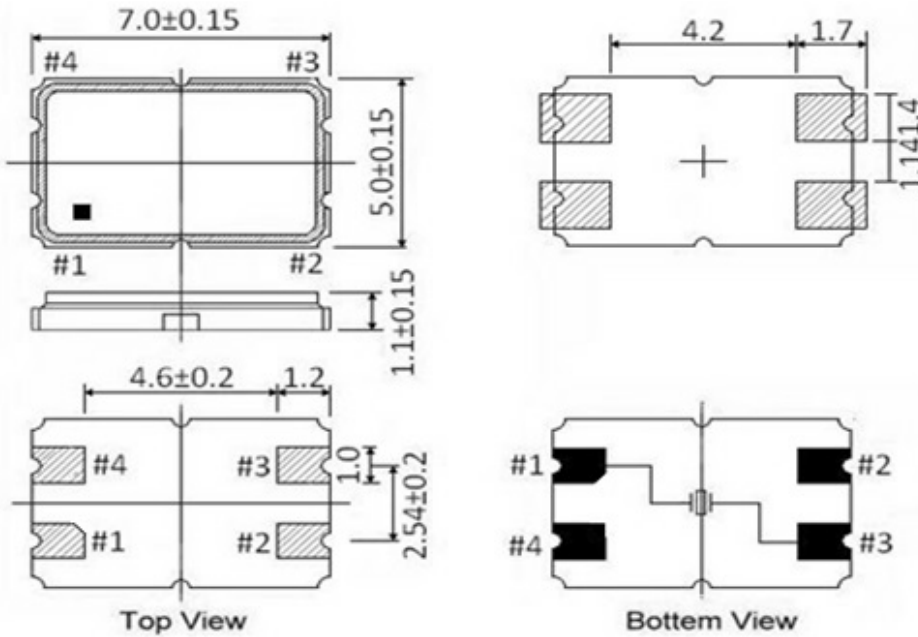

\*\* Recommended - Pin 1 & 3 : CRYSTAL  
Pin 2 & 4 : GND

### Notes:

1. Package drawings are for reference only, and the appearances of objects may vary. Actual packages are based on the real product.
2. The marking dot denotes Pin#1.
3. The position and shape of the chamfer pin may vary and are based on the real product.

# TYPE FP 7x5 SEAM SEALED CRYSTAL

FP2500054

VER.C 01-MAR-18

## Tape & Reel

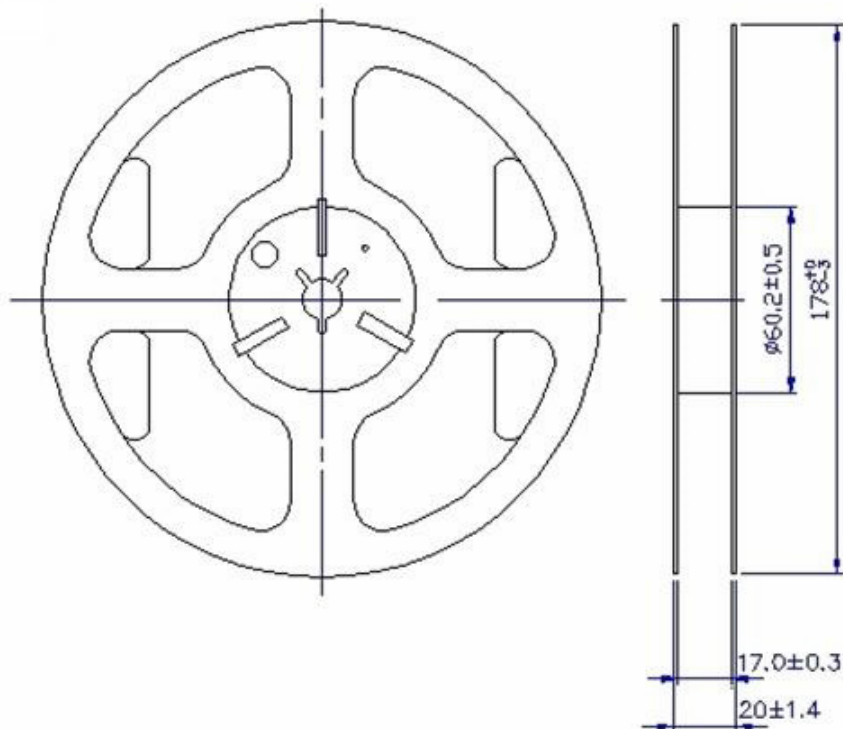
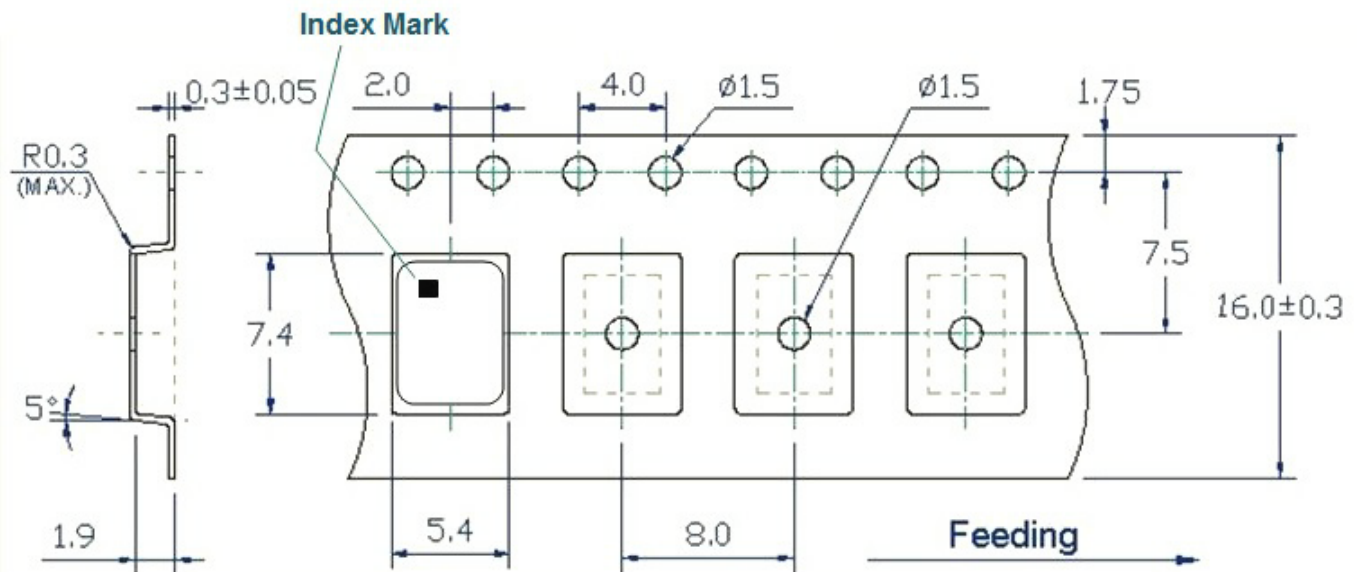

1. 230mm minimum leader which consist of carrier and/or tape followed by a minimum of 160mm of empty carrier tape sealed with cover tape.
2. 160mm minimum trailer of empty carrier tape sealed with cover tape.

# TYPE FP 7x5 SEAM SEALED CRYSTAL

## FP2500054

VER.C 01-MAR-18

### PACKING

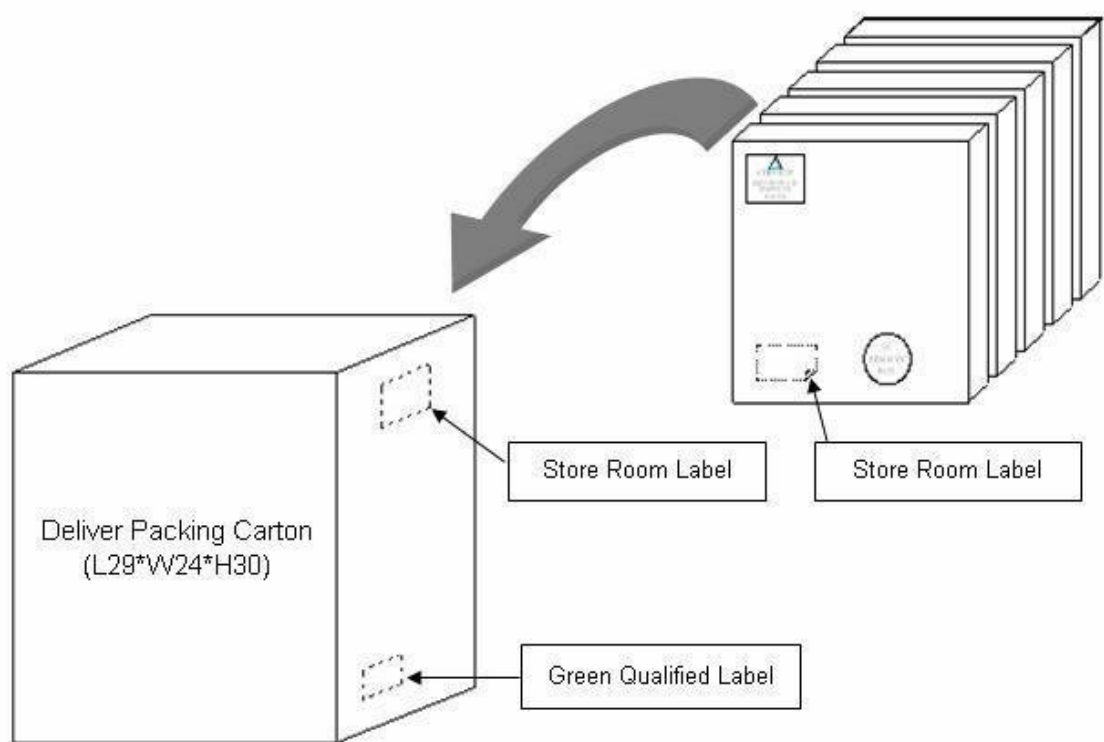
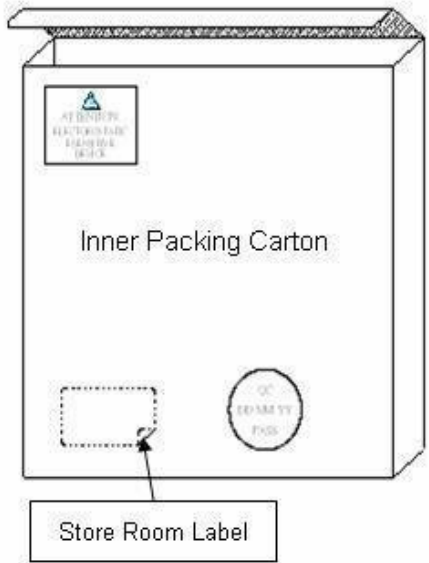
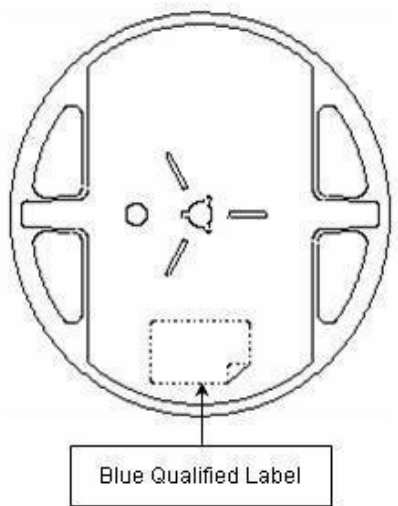
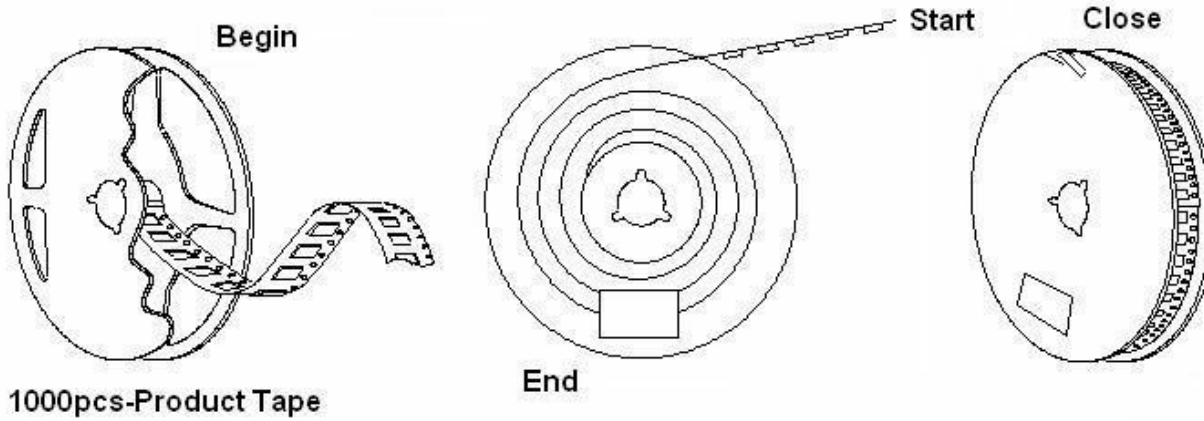

# TYPE FP 7x5 SEAM SEALED CRYSTAL

***FP2500054***

VER.C 01-MAR-18

## VERSION HISTORY

Version No.	Version Date	Description	Notes
C	Mar. 1, 2018	Updated logo	