

SN74LV1T02 Single Power Supply 2-Input Positive NOR Gate CMOS Logic Level Shifter

1 Features

- Single-Supply Voltage Translator at 5.0/3.3/2.5/1.8V V_{CC}
- Operating Range of 1.8V to 5.5V
- Up Translation
 - 1.2V⁽¹⁾ to 1.8V at 1.8V V_{CC}
 - 1.5V⁽¹⁾ to 2.5V at 2.5V V_{CC}
 - 1.8V⁽¹⁾ to 3.3V at 3.3V V_{CC}
 - 3.3V to 5.0V at 5.0V V_{CC}
- Down Translation
 - 3.3V to 1.8V at 1.8V V_{CC}
 - 3.3V to 2.5V at 2.5V V_{CC}
 - 5.0V to 3.3V at 3.3V V_{CC}
- Logic Output is Referenced to V_{CC}
- Output Drive
 - 8mA Output Drive at 5V
 - 7mA Output Drive at 3.3V
 - 3mA Output Drive at 1.8V
- Characterized up to 50MHz at 3.3V V_{CC}
- 5V Tolerance on Input Pins
- –40°C to 125°C Operating Temperature Range
- Pb-Free Packages Available: SC-70 (DCK)
 - 2 × 2.1 × 0.65 mm (Height 1.1mm)
- Latch-Up Performance Exceeds 250mA Per JESD 17
- ESD Performance Tested Per JESD 22
 - 2000-V Human-Body Model (A114-B, Class II)
 - 200-V Machine Model (A115-A)
 - 1000-V Charged-Device Model (C101)
- Supports Standard Logic Pinouts
- CMOS Output B Compatible with AUP1G and LVC1G Families

⁽¹⁾ Refer to the V_{IH}/V_{IL} and output drive for lower V_{CC} condition.

2 Applications

- Industrial controllers
- Telecom
- Portable applications
- Servers
- PC and notebooks
- Automotive

3 Description

SN74LV1T02 is a low voltage CMOS gate logic that operates at a wider voltage range for industrial, portable, telecom, and automotive applications. The output level is referenced to the supply voltage and is able to support 1.8V/2.5V/3.3V/5V CMOS levels.

The input is designed with a lower threshold circuit to match 1.8V input logic at $V_{CC} = 3.3V$ and can be used in 1.8V to 3.3V level up translation. In addition, the 5V tolerant input pins enable down translation (e.g. 3.3V to 2.5V output at $V_{CC} = 2.5V$). The wide V_{CC} range of 1.8V to 5.5V allows generation of desired output levels to connect to controllers or processors.

The SN74LV1T02 is designed with current-drive capability of 8 mA to reduce line reflections, overshoot, and undershoot caused by high-drive outputs.

Device Information

ORDER NUMBER	PACKAGE	BODY SIZE
SN74LV1T02DBVR	SOT-23 (5)	2,90mm x 1,60mm
SN74LV1T02DCKR	SC70 (5)	2,00mm x 1,25mm

DCK or DBV PACKAGE
(TOP VIEW)

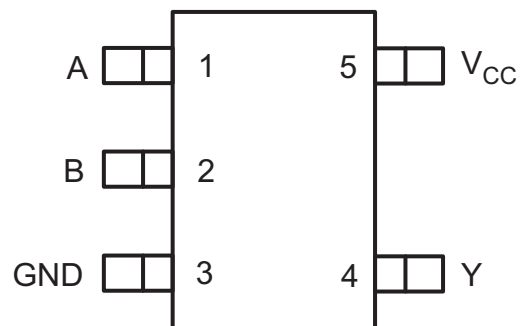

Table of Contents

1 Features	1	4.6 Operating Characteristics	7
2 Applications	1	5 Parameter Measurement Information	8
3 Description	1	5.1 More Product Selection	8
4 Revision History	2	6 Device and Documentation Support	9
4.1 Typical Design Examples	5	6.1 Trademarks	9
4.2 Absolute Maximum Ratings	5	6.2 Electrostatic Discharge Caution	9
4.3 Recommended Operating Conditions	6	6.3 Glossary	9
4.4 Electrical Characteristics	6	7 Mechanical, Packaging, and Orderable Information	9
4.5 Switching Characteristics	7		

4 Revision History

NOTE: Page numbers for previous revisions may differ from page numbers in the current version.

Changes from Original (November 2013) to Revision A	Page
• Updated Electrical Characteristics table.	6
• Removed $I_{OH} = -2.3$ mA test condition for V_{OH} parameter.	6
• Removed $I_{OH} = -2.3$ mA test condition for V_{OL} parameter.	7

Changes from Revision A (September 2013) to Revision B	Page
• Updated document formatting.	1

Function Table

INPUT (Lower Level Input)		OUTPUT (V _{CC} CMOS)
A	B	Y
H	X	L
X	H	L
L	L	H
SUPPLY V _{CC} = 3.3V		
A	B	Y
V _{IH} (min) = 1.35 V V _{IL} (max) = 0.08 V		V _{OH} (min) = 2.9 V V _{OL} (max) = 0.2 V

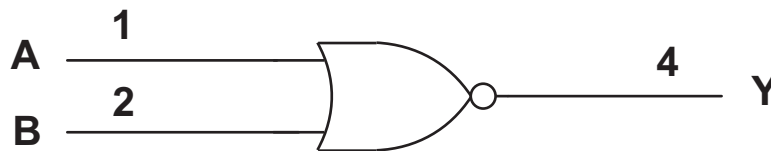

Figure 1. Logic Diagram

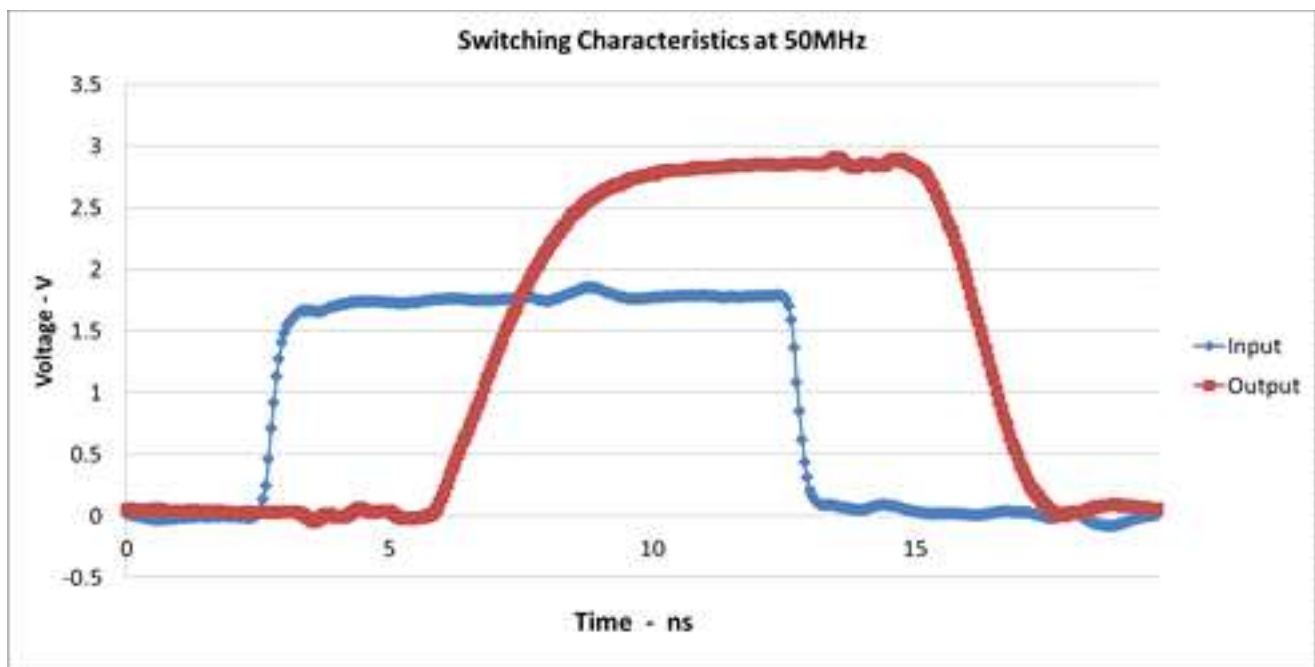

Figure 2. Excellent Signal Integrity (1.8V to 3.3V at 3.3V V_{CC})

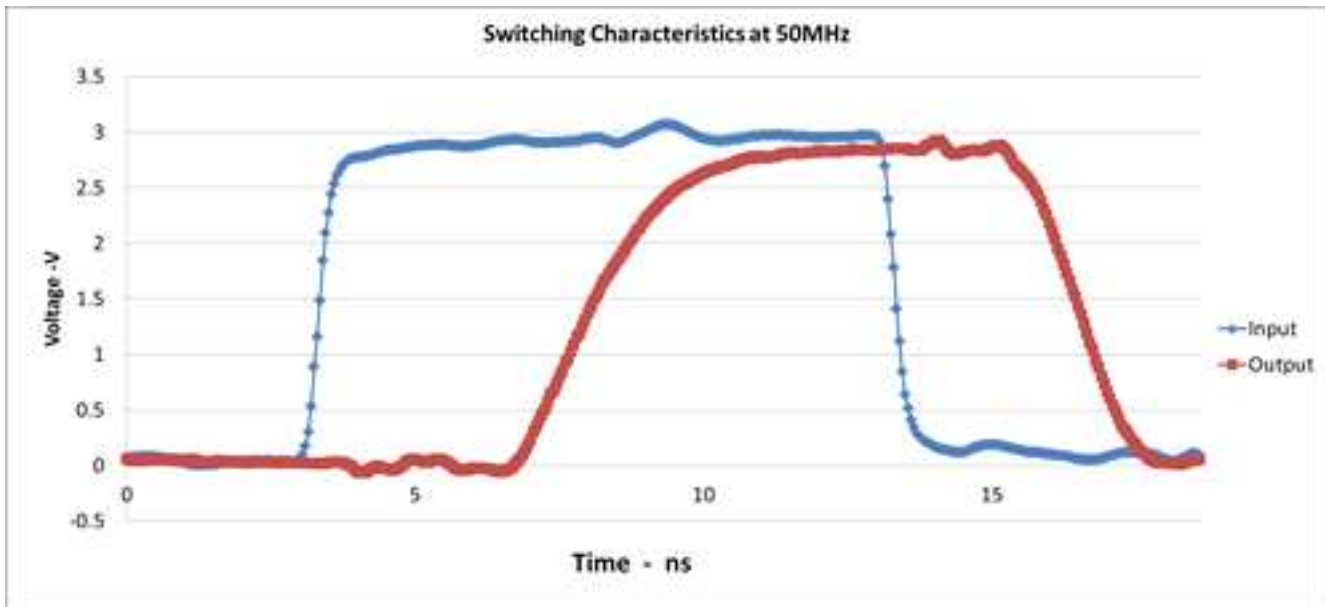

Figure 3. Excellent Signal Integrity (3.3V to 3.3V at 3.3V V_{CC})

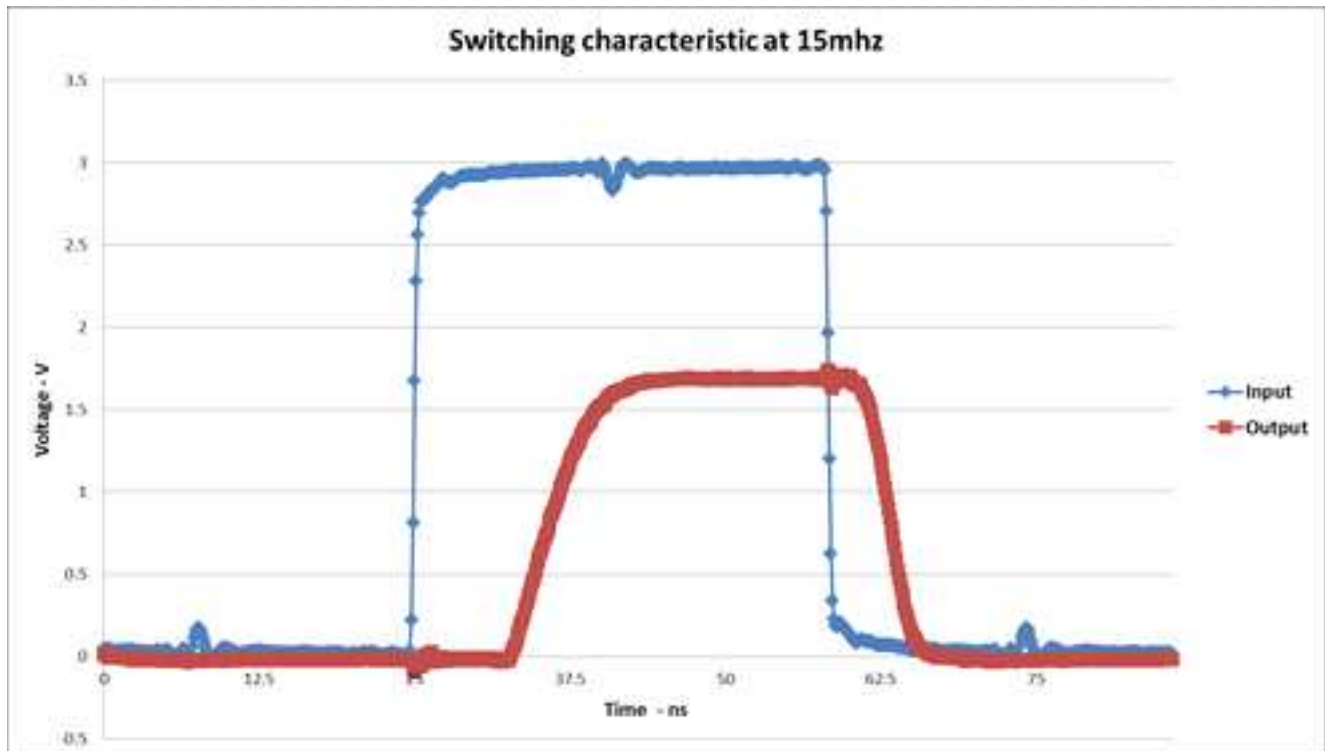

Figure 4. Excellent Signal Integrity (3.3V to 1.8V at 1.8V V_{CC})

4.1 Typical Design Examples

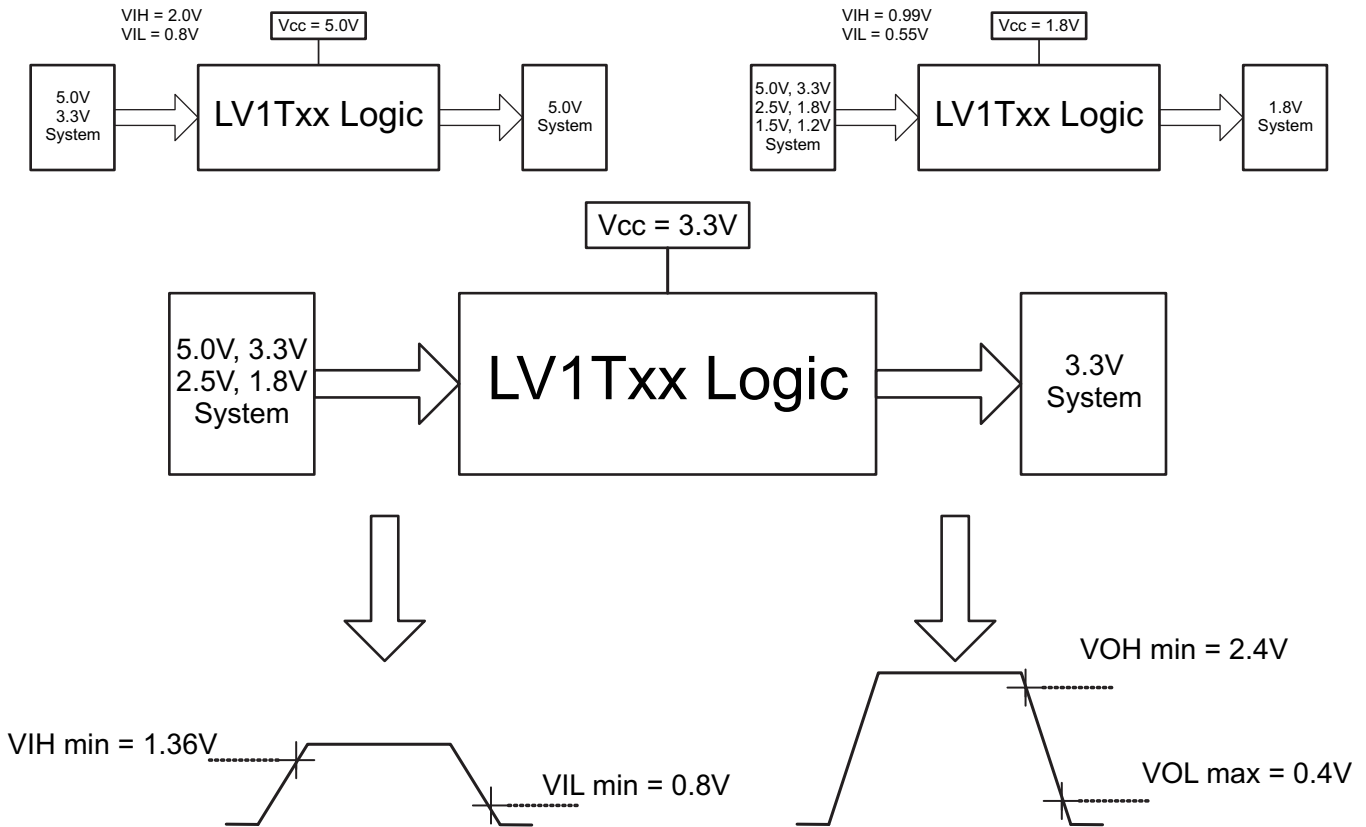

Figure 5. Switching Thresholds for 1.8-V to 3.3-V Translation

4.2 Absolute Maximum Ratings⁽¹⁾

over operating free-air temperature range (unless otherwise noted)

		MIN	MAX	UNIT
V _{CC}	Supply voltage range	-0.5	7.0	V
V _I	Input voltage range ⁽²⁾	-0.5	7.0	V
V _O	Voltage range applied to any output in the high-impedance or power-off state ⁽²⁾	-0.5	4.6	V
	Voltage range applied to any output in the high or low state ⁽²⁾	-0.5	V _{CC} + 0.5	V
I _{IK}	Input clamp current	V _I < 0		-20 mA
I _{OK}	Output clamp current	V _O < 0 or V _O > V _{CC}		±20 mA
I _O	Continuous output current			±25 mA
	Continuous current through V _{CC} or GND			±50 mA
θ _{JA}	Package thermal impedance ⁽³⁾	DBV package		206
		DCK package		252 °C/W
T _{stg}	Storage temperature range	-65	150	°C

- (1) Stresses beyond those listed under "absolute maximum ratings" may cause permanent damage to the device. These are stress ratings only, and functional operation of the device at these or any other conditions beyond those indicated under "recommended operating conditions" is not implied. Exposure to absolute-maximum-rated conditions for extended periods may affect device reliability.
- (2) The input negative-voltage and output voltage ratings may be exceeded if the input and output current ratings are observed.
- (3) The package thermal impedance is calculated in accordance with JESD 51-7.

4.3 Recommended Operating Conditions⁽¹⁾

over operating free-air temperature range (unless otherwise noted)

		MIN	MAX	UNIT	
V_{CC}	Supply voltage	1.6	5.5	V	
V_I	Input voltage	0	5.5	V	
V_O	Output voltage	0	V_{CC}	V	
I_{OH}	High-level output current	$V_{CC} = 1.8\text{ V}$		-3	mA
		$V_{CC} = 2.5\text{ V}$		-5	
		$V_{CC} = 3.3\text{ V}$		-7	
		$V_{CC} = 5.0\text{ V}$		-8	
I_{OL}	Low-level output current	$V_{CC} = 1.8\text{ V}$		3	mA
		$V_{CC} = 2.5\text{ V}$		5	
		$V_{CC} = 3.3\text{ V}$		7	
		$V_{CC} = 5.0\text{ V}$		8	
$\Delta t/\Delta v$	Input transition rise or fall rate	$V_{CC} = 1.8\text{ V}$		20	ns/V
		$V_{CC} = 3.3\text{ V or }2.5\text{ V}$		20	
		$V_{CC} = 5.0\text{ V}$		20	
T_A	Operating free-air temperature	-40	125	°C	

(1) All unused inputs of the device must be held at V_{CC} or GND to ensure proper device operation. Refer to the TI application report, *Implications of Slow or Floating CMOS Inputs*, literature number [SCBA004](#).

4.4 Electrical Characteristics

over recommended operating free-air temperature range (unless otherwise noted)

PARAMETER	TEST CONDITIONS	V_{CC}	$T_A = 25^\circ\text{C}$			$T_A = -40^\circ\text{C to }125^\circ\text{C}$		UNIT
			MIN	TYP	MAX	MIN	MAX	
V_{IH}	High-level input voltage	1.65 V to 1.8 V	0.94			1.0		V
		2.0 V	0.99			1.03		
		2.25 V to 2.5 V	1.135			1.18		
		2.75 V	1.21			1.23		
		3 V to 3.3 V	1.35			1.37		
		3.6 V	1.47			1.48		
		4.5 V to 5.0 V	2.02			2.03		
		5.5 V	2.1			2.11		
V_{IL}	Low-level input voltage	1.65 V to 2.0 V			0.58		0.55	V
		2.25 V to 2.75 V			0.75		0.71	
		3 V to 3.6 V			0.8		0.65	
		4.5 V to 5.5 V			0.8		0.8	
V_{OH}	$I_{OH} = -20\ \mu\text{A}$	1.65 V to 5.5 V	$V_{CC} - 0.1$			$V_{CC} - 0.1$		V
	$I_{OH} = -2.0\ \text{mA}$	1.65 V	1.28			1.21		V
		1.8V	1.5			1.45		V
	$I_{OH} = -3\ \text{mA}$	2.3V	2.0			1.93		V
	$I_{OH} = -3\ \text{mA}$	2.5V	2.25			2.15		V
	$I_{OH} = -3.0\ \text{mA}$	3.0 V		2.78			2.7	V
				2.6			2.49	
	$I_{OH} = -5.5\ \text{mA}$	3.3 V	2.9			2.8		V
	$I_{OH} = -4\ \text{mA}$	4.5 V		4.2			4.1	V
	$I_{OH} = -8\ \text{mA}$			4.1			3.95	
$I_{OH} = -8\ \text{mA}$	5.0 V	4.6			4.5		V	

Electrical Characteristics (continued)

over recommended operating free-air temperature range (unless otherwise noted)

PARAMETER	TEST CONDITIONS	V _{CC}	T _A = 25°C			T _A = -40°C to 125°C		UNIT	
			MIN	TYP	MAX	MIN	MAX		
V _{OL}	I _{OL} = 20 μA	1.65 V to 5.5 V			0.1		0.1	V	
	I _{OL} = 2 A	1.65 V			0.2		0.25		
	I _{OH} = 3 mA	2.3V			0.15		0.2		
	I _{OL} = 3 mA	3.0 V			0.1		0.15		
	I _{OL} = 5.5 mA				0.2		0.252		
	I _{OL} = 4 mA	4.5 V			0.15		0.2		
	I _{OL} = 8 mA				0.3		0.35		
I _i	A input V _I = 0 V or V _{CC}	0V, 1.8V, 2.5V, 3.3V, 5.5 V			0.1		±1	μA	
I _{CC}	V _I = 0 V or V _{CC} , I _O = 0; open on loading	5.0 V			1		10	μA	
		3.3 V			1		10		
		2.5 V			1		10		
		1.8V			1		10		
ΔI _{CC}	One input at 0.3V or 3.4V, Other inputs at 0 or V _{CC} , I _O = 0	5.5 V			1.35		1.5	mA	
	One input at 0.3V or 1.1V Other inputs at 0 or V _{CC} , I _O = 0	1.8V			10		10	μA	
C _i	V _I = V _{CC} or GND	3.3 V			2	10	2	10	pF
C _o	V _O = V _{CC} or GND	3.3 V			2.5		2.5		pF

4.5 Switching Characteristics

over recommended operating free-air temperature range (unless otherwise noted) (see Figure 7)

PARAMETER	FROM (INPUT)	TO (OUTPUT)	FREQUENCY (TYP)	V _{CC}	C _L	T _A = 25°C			T _A = -65°C to 125°C			UNIT
						MIN	TYP	MAX	MIN	TYP	MAX	
t _{pd}	Any In	Y	DC to 50 MHz	5.0V	15pF	4	5		4	5	ns	
					30pF	5.5	7.0		5.5	7.0		
				3.3V	15pF	4.8	5		5	5.5	ns	
					30pF	5	5.5		5.5	6.5		
			DC to 25 MHz	2.5V	15pF	6	6.5		7	7.5	ns	
					30pF	6.5	7.5		7.5	8.5		
				DC to 15 MHz	1.8V	15pF	10.5	11		11	12	ns
						30pF	12	13		12	14	

4.6 Operating Characteristics

T_A = 25°C

PARAMETER	TEST CONDITIONS	V _{CC}	TYP	UNIT
C _{pd} Power dissipation capacitance	f = 1 MHz and 10 MHz	1.8 V ± 0.15 V	14	pF
		2.5 V ± 0.2 V	14	
		3.3 V ± 0.3 V	14	
		5.5 V ± 0.5 V	14	

5 Parameter Measurement Information

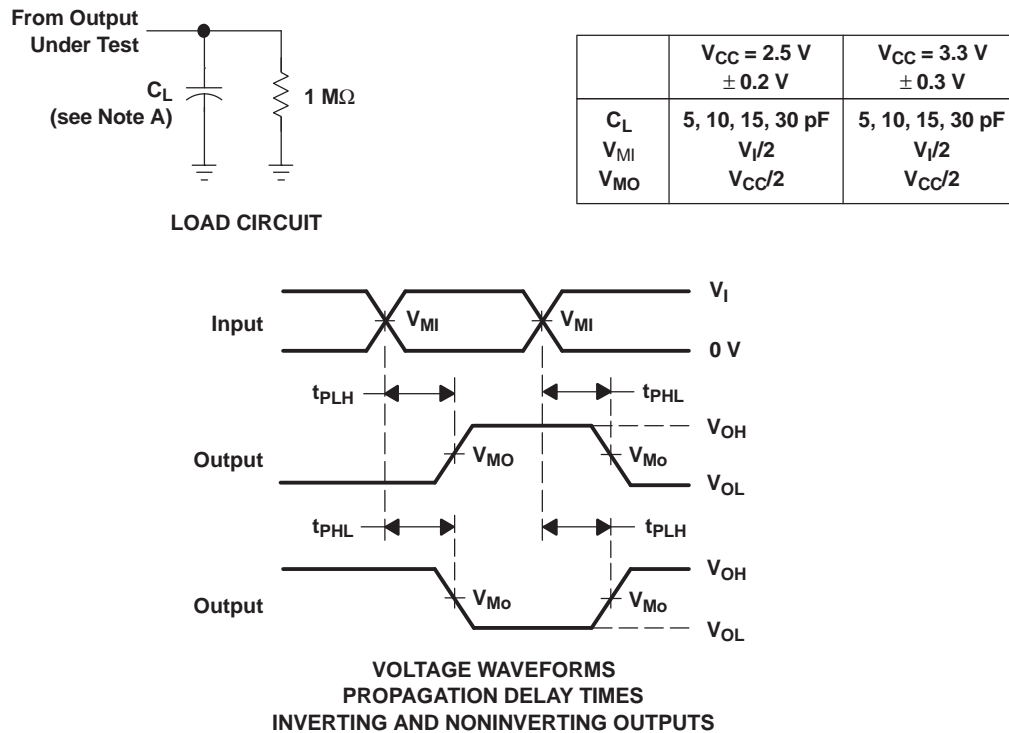

- NOTES: A. C_L includes probe and jig capacitance.
 B. All input pulses are supplied by generators having the following characteristics: PRR \leq 10 MHz, $Z_O = 50 \Omega$, slew rate \geq 1 V/ns.
 C. The outputs are measured one at a time, with one transition per measurement.
 D. t_{PLH} and t_{PHL} are the same as t_{pd} .

Figure 6. Load Circuit and Voltage Waveforms

5.1 More Product Selection

DEVICE	PACKAGE	DESCRIPTION
SN74LV1T00	DCK, DBV	2-Input Positive-NAND Gate
SN74LV1T02	DCK, DBV	2-Input Positive-NOR Gate
SN74LV1T08	DCK, DBV	Inverter Gate
SN74LV1T08	DCK, DBV	2-Input Positive-AND Gate
SN74LV1T17	DCK, DBV	Single Buffer Gate with 3-state Output
SN74LV1T14	DCK, DBV	Single Schmitt-Trigger Inverter Gate
SN74LV1T32	DCK, DBV	2-Input Positive-OR Gate
SN74LV1T50	DCK, DBV	Single Buffer Gate with 3-state Output
SN74LV1T86	DCK, DBV	Single 2-Input Exclusive-Or Gate
SN74LV1T125	DCK, DBV	Single Buffer Gate with 3-state Output
SN74LV1T126	DCK, DBV	Single Buffer Gate with 3-state Output
SN74LV4T125	RGY, PW	Quadruple Bus Buffer Gate With 3-State Outputs

6 Device and Documentation Support

6.1 Trademarks

All trademarks are the property of their respective owners.

6.2 Electrostatic Discharge Caution



These devices have limited built-in ESD protection. The leads should be shorted together or the device placed in conductive foam during storage or handling to prevent electrostatic damage to the MOS gates.

6.3 Glossary

[SLYZ022](#) — *TI Glossary*.

This glossary lists and explains terms, acronyms and definitions.

7 Mechanical, Packaging, and Orderable Information

The following packaging information and addendum reflect the most current data available for the designated devices. This data is subject to change without notice and revision of this document.

PACKAGING INFORMATION

Orderable Device	Status (1)	Package Type	Package Drawing	Pins	Package Qty	Eco Plan (2)	Lead finish/ Ball material (6)	MSL Peak Temp (3)	Op Temp (°C)	Device Marking (4/5)	Samples
SN74LV1T02DBVR	ACTIVE	SOT-23	DBV	5	3000	RoHS & Green	NIPDAU SN	Level-1-260C-UNLIM	-40 to 125	(NEB3, NEBJ, NEBS)	Samples
SN74LV1T02DBVRG4	ACTIVE	SOT-23	DBV	5	3000	RoHS & Green	NIPDAU	Level-1-260C-UNLIM	-40 to 125	NEB3	Samples
SN74LV1T02DCKR	ACTIVE	SC70	DCK	5	3000	RoHS & Green	NIPDAU SN	Level-1-260C-UNLIM	-40 to 125	(WB3, WBJ, WBS)	Samples
SN74LV1T02DCKRG4	ACTIVE	SC70	DCK	5	3000	RoHS & Green	NIPDAU	Level-1-260C-UNLIM		WB3	Samples

(1) The marketing status values are defined as follows:

ACTIVE: Product device recommended for new designs.

LIFEBUY: TI has announced that the device will be discontinued, and a lifetime-buy period is in effect.

NRND: Not recommended for new designs. Device is in production to support existing customers, but TI does not recommend using this part in a new design.

PREVIEW: Device has been announced but is not in production. Samples may or may not be available.

OBSELETE: TI has discontinued the production of the device.

(2) **RoHS:** TI defines "RoHS" to mean semiconductor products that are compliant with the current EU RoHS requirements for all 10 RoHS substances, including the requirement that RoHS substance do not exceed 0.1% by weight in homogeneous materials. Where designed to be soldered at high temperatures, "RoHS" products are suitable for use in specified lead-free processes. TI may reference these types of products as "Pb-Free".

RoHS Exempt: TI defines "RoHS Exempt" to mean products that contain lead but are compliant with EU RoHS pursuant to a specific EU RoHS exemption.

Green: TI defines "Green" to mean the content of Chlorine (Cl) and Bromine (Br) based flame retardants meet JS709B low halogen requirements of <=1000ppm threshold. Antimony trioxide based flame retardants must also meet the <=1000ppm threshold requirement.

(3) MSL, Peak Temp. - The Moisture Sensitivity Level rating according to the JEDEC industry standard classifications, and peak solder temperature.

(4) There may be additional marking, which relates to the logo, the lot trace code information, or the environmental category on the device.

(5) Multiple Device Markings will be inside parentheses. Only one Device Marking contained in parentheses and separated by a "~" will appear on a device. If a line is indented then it is a continuation of the previous line and the two combined represent the entire Device Marking for that device.

(6) Lead finish/Ball material - Orderable Devices may have multiple material finish options. Finish options are separated by a vertical ruled line. Lead finish/Ball material values may wrap to two lines if the finish value exceeds the maximum column width.

Important Information and Disclaimer:The information provided on this page represents TI's knowledge and belief as of the date that it is provided. TI bases its knowledge and belief on information provided by third parties, and makes no representation or warranty as to the accuracy of such information. Efforts are underway to better integrate information from third parties. TI has taken and

continues to take reasonable steps to provide representative and accurate information but may not have conducted destructive testing or chemical analysis on incoming materials and chemicals. TI and TI suppliers consider certain information to be proprietary, and thus CAS numbers and other limited information may not be available for release.

In no event shall TI's liability arising out of such information exceed the total purchase price of the TI part(s) at issue in this document sold by TI to Customer on an annual basis.

TAPE AND REEL INFORMATION

QUADRANT ASSIGNMENTS FOR PIN 1 ORIENTATION IN TAPE

*All dimensions are nominal

Device	Package Type	Package Drawing	Pins	SPQ	Reel Diameter (mm)	Reel Width W1 (mm)	A0 (mm)	B0 (mm)	K0 (mm)	P1 (mm)	W (mm)	Pin1 Quadrant
SN74LV1T02DBVR	SOT-23	DBV	5	3000	180.0	8.4	3.23	3.17	1.37	4.0	8.0	Q3
SN74LV1T02DBVR	SOT-23	DBV	5	3000	178.0	9.0	3.3	3.2	1.4	4.0	8.0	Q3
SN74LV1T02DBVR	SOT-23	DBV	5	3000	178.0	9.2	3.3	3.23	1.55	4.0	8.0	Q3
SN74LV1T02DBVRG4	SOT-23	DBV	5	3000	178.0	9.2	3.3	3.23	1.55	4.0	8.0	Q3
SN74LV1T02DCKR	SC70	DCK	5	3000	178.0	9.2	2.4	2.4	1.22	4.0	8.0	Q3
SN74LV1T02DCKR	SC70	DCK	5	3000	180.0	8.4	2.47	2.3	1.25	4.0	8.0	Q3
SN74LV1T02DCKR	SC70	DCK	5	3000	178.0	9.0	2.4	2.5	1.2	4.0	8.0	Q3
SN74LV1T02DCKRG4	SC70	DCK	5	3000	178.0	9.2	2.4	2.4	1.22	4.0	8.0	Q3

TAPE AND REEL BOX DIMENSIONS

*All dimensions are nominal

Device	Package Type	Package Drawing	Pins	SPQ	Length (mm)	Width (mm)	Height (mm)
SN74LV1T02DBVR	SOT-23	DBV	5	3000	202.0	201.0	28.0
SN74LV1T02DBVR	SOT-23	DBV	5	3000	180.0	180.0	18.0
SN74LV1T02DBVR	SOT-23	DBV	5	3000	180.0	180.0	18.0
SN74LV1T02DBVRG4	SOT-23	DBV	5	3000	180.0	180.0	18.0
SN74LV1T02DCKR	SC70	DCK	5	3000	180.0	180.0	18.0
SN74LV1T02DCKR	SC70	DCK	5	3000	202.0	201.0	28.0
SN74LV1T02DCKR	SC70	DCK	5	3000	180.0	180.0	18.0
SN74LV1T02DCKRG4	SC70	DCK	5	3000	180.0	180.0	18.0

EXAMPLE BOARD LAYOUT

DBV0005A

SOT-23 - 1.45 mm max height

SMALL OUTLINE TRANSISTOR



LAND PATTERN EXAMPLE
EXPOSED METAL SHOWN
SCALE:15X



SOLDER MASK DETAILS

4214839/F 06/2021

NOTES: (continued)

- 5. Publication IPC-7351 may have alternate designs.
- 6. Solder mask tolerances between and around signal pads can vary based on board fabrication site.

EXAMPLE STENCIL DESIGN

DBV0005A

SOT-23 - 1.45 mm max height

SMALL OUTLINE TRANSISTOR



SOLDER PASTE EXAMPLE
BASED ON 0.125 mm THICK STENCIL
SCALE:15X

4214839/F 06/2021

NOTES: (continued)

7. Laser cutting apertures with trapezoidal walls and rounded corners may offer better paste release. IPC-7525 may have alternate design recommendations.
8. Board assembly site may have different recommendations for stencil design.

DCK (R-PDSO-G5)

PLASTIC SMALL-OUTLINE PACKAGE



- NOTES:
- A. All linear dimensions are in millimeters.
 - B. This drawing is subject to change without notice.
 - C. Body dimensions do not include mold flash or protrusion. Mold flash and protrusion shall not exceed 0.15 per side.
 - D. Falls within JEDEC MO-203 variation AA.

DCK (R-PDSO-G5)

PLASTIC SMALL OUTLINE



- NOTES:
- A. All linear dimensions are in millimeters.
 - B. This drawing is subject to change without notice.
 - C. Customers should place a note on the circuit board fabrication drawing not to alter the center solder mask defined pad.
 - D. Publication IPC-7351 is recommended for alternate designs.
 - E. Laser cutting apertures with trapezoidal walls and also rounding corners will offer better paste release. Customers should contact their board assembly site for stencil design recommendations. Example stencil design based on a 50% volumetric metal load solder paste. Refer to IPC-7525 for other stencil recommendations.

IMPORTANT NOTICE AND DISCLAIMER

TI PROVIDES TECHNICAL AND RELIABILITY DATA (INCLUDING DATASHEETS), DESIGN RESOURCES (INCLUDING REFERENCE DESIGNS), APPLICATION OR OTHER DESIGN ADVICE, WEB TOOLS, SAFETY INFORMATION, AND OTHER RESOURCES "AS IS" AND WITH ALL FAULTS, AND DISCLAIMS ALL WARRANTIES, EXPRESS AND IMPLIED, INCLUDING WITHOUT LIMITATION ANY IMPLIED WARRANTIES OF MERCHANTABILITY, FITNESS FOR A PARTICULAR PURPOSE OR NON-INFRINGEMENT OF THIRD PARTY INTELLECTUAL PROPERTY RIGHTS.

These resources are intended for skilled developers designing with TI products. You are solely responsible for (1) selecting the appropriate TI products for your application, (2) designing, validating and testing your application, and (3) ensuring your application meets applicable standards, and any other safety, security, or other requirements. These resources are subject to change without notice. TI grants you permission to use these resources only for development of an application that uses the TI products described in the resource. Other reproduction and display of these resources is prohibited. No license is granted to any other TI intellectual property right or to any third party intellectual property right. TI disclaims responsibility for, and you will fully indemnify TI and its representatives against, any claims, damages, costs, losses, and liabilities arising out of your use of these resources.

TI's products are provided subject to TI's Terms of Sale (<https://www.ti.com/legal/termsofsale.html>) or other applicable terms available either on [ti.com](https://www.ti.com) or provided in conjunction with such TI products. TI's provision of these resources does not expand or otherwise alter TI's applicable warranties or warranty disclaimers for TI products.

Mailing Address: Texas Instruments, Post Office Box 655303, Dallas, Texas 75265
Copyright © 2021, Texas Instruments Incorporated