

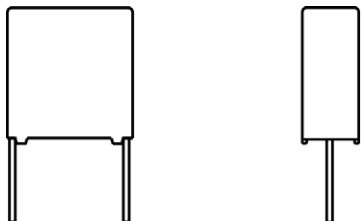

Interference Suppression Film Capacitors MKP Radial Potted Type



FEATURES

- AEC-Q200 qualified
- THB grade IIB compliant (pitch ≥ 15 mm):
85 °C, 85 % RH, 500 h at U_{RAC}
- Material categorization:
for definitions of compliance please see
www.vishay.com/doc?99912

AUTOMOTIVE
GRADE





RoHS
COMPLIANT

APPLICATIONS

For standard line bypass (between line and ground) Y2 applications

See also application note: www.vishay.com/doc?28153

QUICK REFERENCE DATA	
Capacitance range (E12 series)	0.001 μ F to 0.1 μ F (preferred values acc. to E6)
Capacitance tolerance	± 20 %
Rated voltage	300 V_{AC} ; 50 Hz to 60 Hz
Permissible DC voltage	1000 V_{DC}
Climatic testing class (according to EN 60068-1)	55/105/56/C for product volumes ≤ 1750 mm ³
	55/105/56/B for product volumes > 1750 mm ³
Maximum application temperature	105 °C
Reference standards	IEC 60384-14 ed-4 (2013) and EN 60384-14 IEC 60065 requires pass. flamm. class B for volumes > 1750 mm ³ UL 60384-14 2 nd edition; CSA E60384-1:14 3 rd edition
Dielectric	Polypropylene film
Electrodes	Metallized film
Construction	Series construction 
	Triple construction 
Encapsulation	Plastic case, epoxy resin sealed, flame retardant class UL 94 V-0
Terminals	Tinned wire
Marking	C-value; tolerance; rated voltage; sub-class; manufacturer's type designation; code for dielectric material, manufacturer location; manufacturer's logo, year and week; safety approvals

Note

- For more detailed data and test requirements, contact rfi@vishay.com

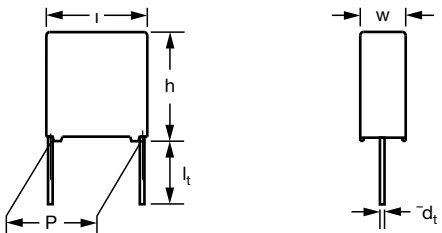
DIMENSIONS



COMPOSITION OF CATALOG NUMBER

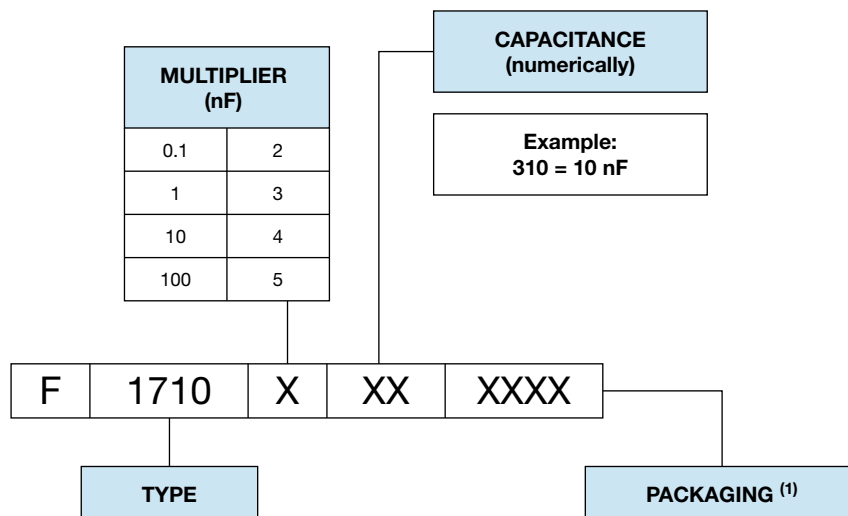

Note

(1) For detailed tape specification refer to "Packaging Information" www.vishay.com/doc?28139

SPECIFIC REFERENCE DATA		
DESCRIPTION	VALUE	
Rated AC voltage (U_{RAC})	300 V	
Permissible DC voltage (U_{RDC})	1000 V	
Tangent of loss angle $C \leq 100$ nF	At 1 kHz	At 10 kHz
	$\leq 10 \times 10^{-4}$	$\leq 20 \times 10^{-4}$
Rated voltage pulse slope (dU/dt) _R at 420 V _{DC}	100 V/ μ s	
R between leads at 100 V; 1 min	> 15 000 M Ω	
R between leads and case; 100 V; 1 min	> 30 000 M Ω	
Withstanding (DC) voltage (cut off current 10 mA) (1); rise time ≤ 1000 V/s	3400 V; 1 min	
Withstanding (AC) voltage between leads and case	2100 V; 1 min	
Maximum application temperature	105 °C	

Note

(1) See "Voltage Proof Test for Metalized Film Capacitors": www.vishay.com/doc?28169



ELECTRICAL DATA AND ORDERING INFORMATION													
U _{RDC} (V)	CAP. (µF)	DIMENSIONS w x h x l (mm)	MASS (g) ⁽³⁾	CATALOG NUMBER F1710... AND PACKAGING									
				LOOSE IN BOX					TAPED				
				SHORT LEADS			LONG LEADS		REEL: Ø = 500 mm ⁽¹⁾⁽²⁾ H = 18.5 mm; P ₀ = 12.7 mm				
				l _t = 4 mm - 1 mm	l _t = 6.0 mm - 1.0 mm	SPQ	l _t = 30.0 mm + 5.0 mm	SPQ	SPQ				
PITCH = 15 mm ± 0.4 mm; d_t = 0.60 mm ± 0.06 mm; C-TOL. = ± 20 %													
1000	0.0010	5.0 x 11.0 x 17.5	1	2101004	2101000	750	2101030	900	2101901	1000			
	0.0012			2121004	2121000		2121030		2121901				
	0.0015			2151004	2151000		2151030		2151901				
	0.0018			2181004	2181000		2181030		2181901				
	0.0022			2221004	2221000		2221030		2221901				
	0.0027			2271004	2271000		2271030		2271901				
	0.0033			2331004	2331000		2331030		2331901				
	0.0039			2391004	2391000		2391030		2391901				
	0.0047			2471004	2471000		2471030		2471901				
	0.0056			2561004	2561000		2561030		2561901				
	0.0068			2681004	2681000		2681030		2681901				
	0.0082			2821004	2821000		500		2821030		750	2821901	1000
	0.010			3101004	3101000				3101030			3101901	
	0.012	6.0 x 12.0 x 17.5	1.4	450	3121004	3121000	500	3121030	3121901	800			
0.015	3151004				3151000	3151030		3151901					
0.018			300	3181004	3181000	500	3181030	3181901	700				
PITCH = 15 mm ± 0.4 mm; d_t = 0.80 mm ± 0.08 mm; C-TOL. = ± 20 %													
0.022	7.0 x 13.5 x 17.5	1.8	300	3221004	3221000	300	3221030	500	3221901	700			
PITCH = 22.5 mm ± 0.4 mm; d_t = 0.80 mm ± 0.08 mm; C-TOL. = ± 20 %													
0.027	6.0 x 15.5 x 26.0	2.4	260	3271004	3271000	750	3271030	750	3271901	600			
0.033				3331004	3331000		3331030		3331901				
0.039	7.0 x 16.5 x 26.0	2.9	235	3391004	3391000	750	3391030	750	3391901	500			
0.047				3471004	3471000		3471030		3471901		450		
0.056				3561004	3561000		170		3561030			500	3561901
0.068	8.5 x 18.0 x 26.0	3.8	3681004	3681000	3681030	500		3681901	400				
PITCH = 27.5 mm ± 0.4 mm; d_t = 0.80 mm ± 0.08 mm; C-TOL. = ± 20 %													
0.082	9.0 x 19.0 x 31.0	5.5	125	3821004	3821000	400	3821030	400	3821901	250			
0.100				4101004	4101000		4101030		4101901				

Notes

- SPQ = Standard Packing Quantity
- (1) Reel diameter = 365 mm is available on request
- (2) H = In-tape height; P₀ = Sprocket hole distance; for detailed specifications refer to "Packaging Information"
- (3) Weight for short lead product only



APPROVALS				
SAFETY APPROVALS Y2	VOLTAGE	VALUE	FILE NUMBERS	LINKS
EN 60384-14 (ENEC) (= IEC 60384-14 ed-4 (2013))	300 V _{AC}	0.001 µF to 0.1 µF	ENEC16/FI/19/10000	www.vishay.com/doc?28212
UL 60384-14 2 nd edition	300 V _{AC}	0.001 µF to 0.1 µF	E354331	www.vishay.com/doc?28189
CSA E60384-1:14 3 rd edition	300 V _{AC}	0.001 µF to 0.1 µF	E354331	
CB-test certificate	300 V _{AC}	0.001 µF to 0.1 µF	FI-39810	www.vishay.com/doc?28213
The ENEC-approval together with the CB-certificate replace all national marks of the following countries (they have already signed the ENEC-agreement): Austria; Belgium; Czech. Republic; Denmark; Finland; France; Germany; Greece; Hungary; Ireland; Italy; Luxembourg; Netherlands; Norway; Portugal; Slovenian; Spain; Sweden, Switzerland and United Kingdom.				

MOUNTING

Normal Use

The capacitors are designed for mounting on printed-circuit boards. The capacitors packed in bandoleers are designed for mounting in printed circuit boards by means of automatic insertion machines.

For detailed tape specifications refer to packaging information: www.vishay.com/doc?28139

Specific Method of Mounting to Withstand Vibration and Shock

In order to withstand vibration and shock tests, it must be ensured that the stand-off pips are in good contact with the printed-circuit board:

- For pitches ≤ 15 mm capacitors shall be mechanically fixed by the leads
- For larger pitches the capacitors shall be mounted in the same way and the body clamped

Space Requirements on Printed-Circuit Board

The maximum space for length ($l_{max.}$), width ($w_{max.}$), and height ($h_{max.}$) of film capacitors to take in account on the printed-circuit board is shown in the drawings:

- For products with pitch ≤ 15 mm, $\Delta w = \Delta l = 0.3$ mm; $\Delta h = 0.1$ mm
- For products with 15 mm < pitch, ≤ 27.5 mm, $\Delta w = \Delta l = 0.5$ mm; $\Delta h = 0.1$ mm

Eccentricity defined as in drawing. The maximum eccentricity is smaller than or equal to the lead diameter of the product concerned.

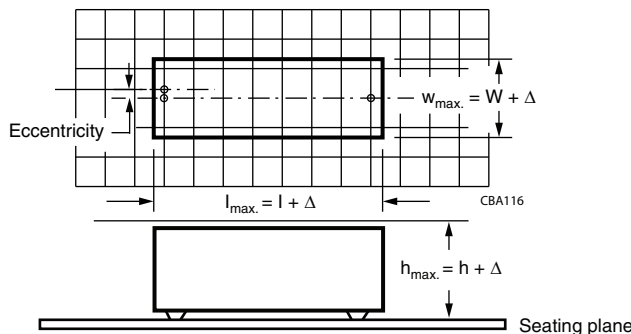

SOLDERING CONDITIONS

For general soldering conditions and wave soldering profile, we refer to the application note: "Soldering Guidelines for Film Capacitors": www.vishay.com/doc?28171

Storage Temperature

$T_{stg} = -25$ °C to $+35$ °C with RH maximum 75 % without condensation

Ratings and Characteristics Reference Conditions

Unless otherwise specified, all electrical values apply to an ambient temperature of 23 °C ± 1 °C, an atmospheric pressure of 86 kPa to 106 kPa and a relative humidity of 50 % ± 2 %.

For reference testing, a conditioning period shall be applied over 96 h ± 4 h by heating the products in a circulating air oven at the rated temperature and a relative humidity not exceeding 20 %.



CHARACTERISTICS

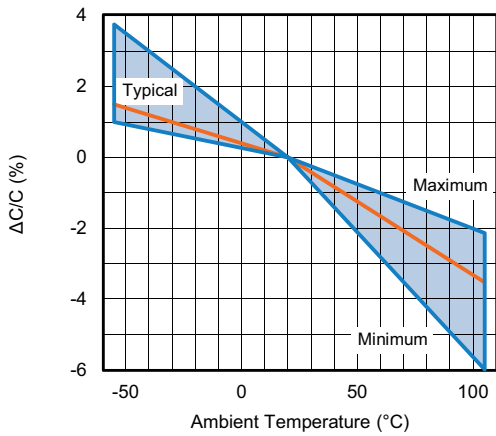

Capacitance as a function of ambient temperature (typical curve)

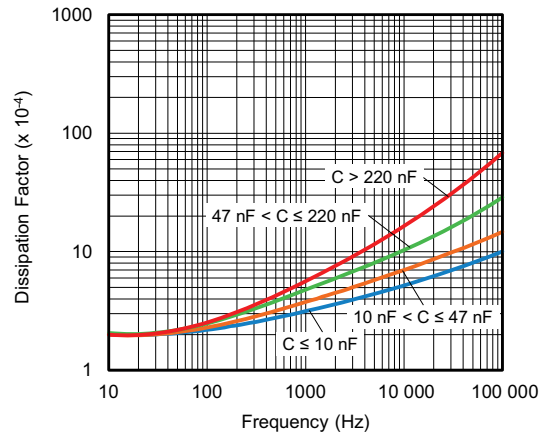

Tangent of loss angle as a function of frequency (typical curve)

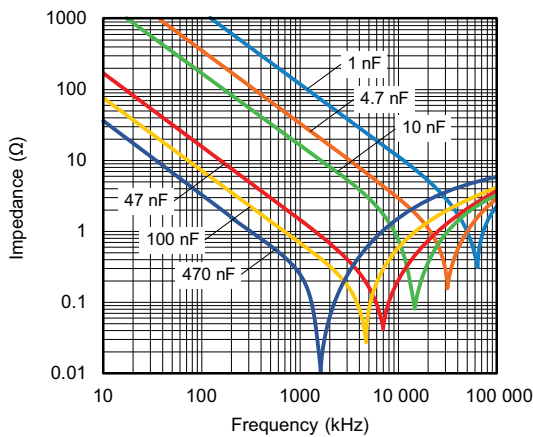

Impedance as a function of frequency (typical curve)

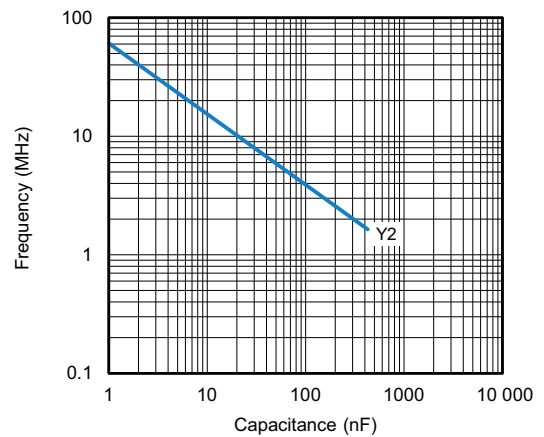

Resonant frequency as a function of capacitance (typical curve)

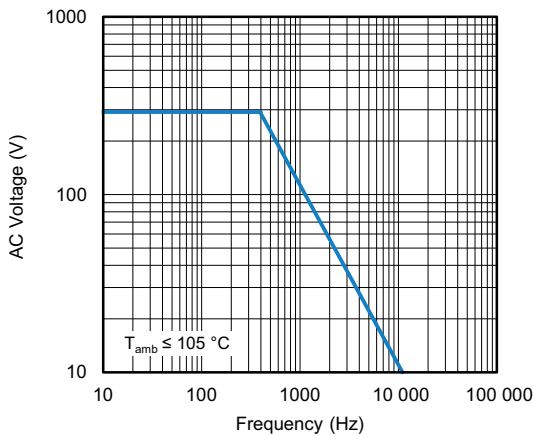

Max. RMS voltage as a function of frequency

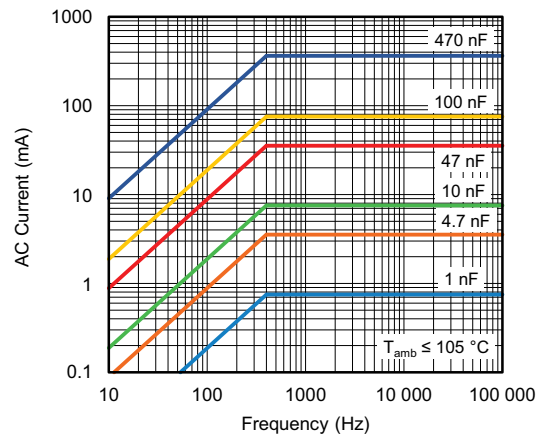

Max. RMS current as a function of frequency

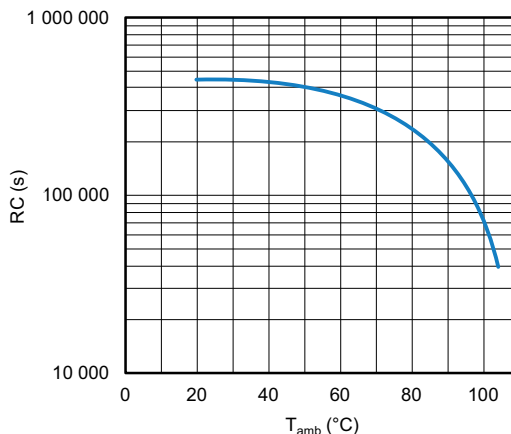

Insulation resistance as a function of ambient temperature

APPLICATION NOTES

- For X2 electromagnetic interference suppression in **standard across the line application** (50 Hz / 60 Hz) with a maximum mains voltage of 310 V_{AC}
- For series impedance applications we refer to the “Application Note”: www.vishay.com/doc?28153
- For capacitors connected in parallel, normally the proof voltage and possibly the rated voltage must be reduced. For information depending of the capacitance value and the number of parallel connections contact: rfi@vishay.com
- These capacitors are not intended for continuous pulse applications. For these situations, capacitors of the AC and pulse program must be used
- The maximum ambient temperature must not exceed 110 °C (125 °C for less than 1000 h) for C ≤ 470 nF and 110 °C for C > 470 nF
- Rated voltage pulse slope:
If the pulse voltage is lower than the rated voltage, the values of the specific reference data can be multiplied by 435 V_{DC} and divided by the applied voltage

INSPECTION REQUIREMENTS

General Notes

Sub-clause numbers of tests and performance requirements refer to the “Sectional Specification, publication IEC 60384-14 ed-4 (2013) and Specific Reference Data”.

GROUP C INSPECTION REQUIREMENTS		
SUB-CLAUSE NUMBER AND TEST	CONDITIONS	PERFORMANCE REQUIREMENTS
SUB-GROUP C-1A PART OF SAMPLE OF SUB-GROUP C-1		
4.1 Dimensions (detail) Initial measurements	Capacitance Tangent of loss angle: at 10 kHz	As specified in chapters “General Data” of this specification
4.3 Robustness of terminations	Tensile: Load 10 N; 10 s Bending: Load 5 N; 4 x 90°	No visible damage
4.4 Resistance to soldering heat	No pre-drying Method: 1A Solder bath: 280 °C ± 5 °C Duration: 10 s	



GROUP C INSPECTION REQUIREMENTS		
SUB-CLAUSE NUMBER AND TEST	CONDITIONS	PERFORMANCE REQUIREMENTS
SUB-GROUP C1A PART OF SAMPLE OF SUB-GROUP C1		
4.19 Component solvent resistance	Isopropylalcohol at room temperature Method: 2 Immersion time: 5 min ± 0.5 min Recovery time: Min. 1 h, max. 2 h	
4.4.2 Final measurements	Visual examination Capacitance Tangent of loss angle Insulation resistance	No visible damage Legible marking $ \Delta C/C \leq 5\%$ of the value measured initially Increase of $\tan \delta \leq 0.008$ Compared to values measured initially As specified in section "Insulation Resistance" of this specification
SUB-GROUP C1B PART OF SAMPLE OF SUB-GROUP C1		
Initial measurements	Capacitance Tangent of loss angle: at 10 kHz	
4.20 Solvent resistance of the marking:	Isopropylalcohol at room temperature Method: 1 Rubbing material: Cotton wool Immersion time: 5 min ± 0.5 min	No visible damage Legible marking
4.6 Rapid change of temperature	$\theta A = -55\text{ }^\circ\text{C}$ $\theta B = +105\text{ }^\circ\text{C}$ 5 cycles Duration $t = 30\text{ min}$	
4.6.1 Inspection 4.7 Vibration	Visual examination Mounting: See section "Mounting" of this specification Procedure B4: Frequency range: 10 Hz to 55 Hz Amplitude: 0.75 mm or Acceleration 98 m/s ² (whichever is less severe) Total duration 6 h	No visible damage
4.7.2 Final inspection	Visual examination	No visible damage
4.9 Shock	Mounting: See section "Mounting" for more information Pulse shape: Half sine Acceleration: 490 m/s ² Duration of pulse: 11 ms	
4.9.2 Final measurements	Visual examination Capacitance Tangent of loss angle Insulation resistance	No visible damage $ \Delta C/C \leq 5\%$ of the value measured initially Increase of $\tan \delta \leq 0.008$ Compared to values measured initially As specified in section "Insulation Resistance" of this specification



GROUP C INSPECTION REQUIREMENTS		
SUB-CLAUSE NUMBER AND TEST	CONDITIONS	PERFORMANCE REQUIREMENTS
SUB-GROUP C1 COMBINED SAMPLE OF SPECIMENS OF SUB-GROUPS C1A AND C1B		
4.11 Climatic sequence		
4.11.1 Initial measurements	Capacitance Measured in 4.4.2 and 4.9.2 Tangent of loss angle: Measured initially in C1A and C1B	
4.11.2 Dry heat	Temperature: 105 °C Duration: 16 h	
4.11.3 Damp heat cyclic Test Db First cycle		
4.11.4 Cold	Temperature: - 55 °C Duration: 2 h	
4.11.5 Damp heat cyclic Test Db remaining cycles		
4.11.6 Final measurements	Visual examination Capacitance Tangent of loss angle Voltage proof 2250 V _{DC} ; 1 min between terminations Insulation resistance	No visible damage Legible marking $ \Delta C/C \leq 5\%$ of the value measured in 4.11.1. Increase of $\tan \delta \leq 0.008$ Compared to values measured in 4.11.1 No permanent breakdown or flash-over $\geq 50\%$ of values specified in section "Insulation Resistance" of this specification
SUB-GROUP C2		
4.12 Damp heat steady state	56 days, 40 °C, 90 % to 95 % RH, no load capacitance	
4.12.1 Initial measurements	Tangent of loss angle at 1 kHz	
4.12.3 Final measurements	Visual examination Capacitance Tangent of loss angle Voltage proof 2250 V _{DC} ; 1 min between terminations Insulation resistance	No visible damage Legible marking $ \Delta C/C \leq 5\%$ of the value measured in 4.12.1. Increase of $\tan \delta \leq 0.007$ Compared to values measured in 4.12.1. No permanent breakdown or flash-over $\geq 50\%$ of values specified in section "Insulation Resistance" of this specification



GROUP C INSPECTION REQUIREMENTS		
SUB-CLAUSE NUMBER AND TEST	CONDITIONS	PERFORMANCE REQUIREMENTS
SUB-GROUP C3		
4.13.1 Initial measurements	Capacitance Tangent of loss angle: at 10 kHz	
4.13 Impulse voltage	3 successive impulses, full wave, peak voltage: X1: 5 kV Max. 24 pulses	No selfhealing breakdowns or flash-over
4.14 Endurance	Duration: 1000 h 1.7 x U _{RAC} at 105 °C Once in every hour the voltage is increased to 1000 V _{RMS} for 0.1 s via resistor of 47 Ω ± 5 %	
4.14.7 Final measurements	Visual examination Capacitance Tangent of loss angle Voltage proof 2250 V _{DC} ; 1 min between terminations 2100 V _{AC} ; 1 min between terminations and case Insulation resistance	No visible damage Legible marking $ \Delta C/C \leq 10\%$ compared to values measured in 4.13.1. Increase of $\tan \delta \leq 0.008$ Compared to values measured in 4.13.1. No permanent breakdown or flash-over $\geq 50\%$ of values specified in section "Insulation Resistance" of this specification
SUB-GROUP C4		
4.15 Charge and discharge	10 000 cycles charged to 420 V _{DC} Discharge resistance: $R = \frac{420 V_{DC}}{1.5 \times C (dU/dt)}$	
4.15.1 Initial measurements	Capacitance Tangent of loss angle: at 10 kHz	
4.15.3 Final measurements	Capacitance Tangent of loss angle Insulation resistance	$ \Delta C/C \leq 10\%$ compared to values measured in 4.15.1. Increase of $\tan \delta \leq 0.008$ Compared to values measured in 4.15.1. $\geq 50\%$ of values specified in section "Insulation Resistance" of this specification
SUB-GROUP C5		
4.16 Radio frequency characteristic	Resonance frequency	≥ 0.9 times the value as specified in section "Resonant Frequency" of this specification

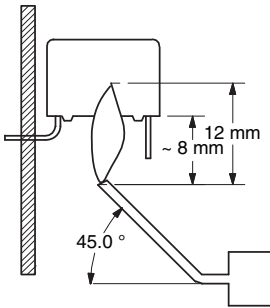

GROUP C INSPECTION REQUIREMENTS		
SUB-CLAUSE NUMBER AND TEST	CONDITIONS	PERFORMANCE REQUIREMENTS
SUB-GROUP C6		
4.17 Passive flammability Class B/C	Bore of gas jet: $\varnothing 0.5 \text{ mm}$ Fuel: Butane Test duration for actual volume V in mm^3 : $V \leq 250$: 5 s $250 < V \leq 500$: 10 s $500 < V \leq 1750$: 20 s $V > 1750$: 60 s One flame application 	After removing test flame from capacitor, the capacitor must not continue to burn for more than 30 s for $V \leq 1750 \text{ mm}^3$ and 10 s for $V > 1750 \text{ mm}^3$. No burning particle must drop from the sample.
SUB-GROUP C7		
4.18 Active flammability	20 cycles of 5 kV discharges on the test capacitor connected to U_{RAC}	The cheese cloth around the capacitors shall not burn with a flame. No electrical measurements are required.
SUB-GROUP ADD6 (FOR PITCH $\geq 15 \text{ mm}$)		
A.6 Damp heat steady state with load	RH: 85 %, temp.: 85 °C Load: 300 V _{AC} , duration: 500 h	
A.6.1 Initial measurements	Capacitance Tangent of loss angle: at 10 kHz	
A.6.2 Final measurements	Visual examination Capacitance Tangent of loss angle Insulation resistance	No visible damage Legible marking $ \Delta C/C \leq 10 \%$ of the value measured in A.6.1 Increase of $\tan \delta \leq 0.024$ Compared to values measured in A.6.1 No permanent breakdown or flash-over $\geq 50 \%$ of values specified in section "Insulation Resistance" of this specification



Disclaimer

ALL PRODUCT, PRODUCT SPECIFICATIONS AND DATA ARE SUBJECT TO CHANGE WITHOUT NOTICE TO IMPROVE RELIABILITY, FUNCTION OR DESIGN OR OTHERWISE.

Vishay Intertechnology, Inc., its affiliates, agents, and employees, and all persons acting on its or their behalf (collectively, "Vishay"), disclaim any and all liability for any errors, inaccuracies or incompleteness contained in any datasheet or in any other disclosure relating to any product.

Vishay makes no warranty, representation or guarantee regarding the suitability of the products for any particular purpose or the continuing production of any product. To the maximum extent permitted by applicable law, Vishay disclaims (i) any and all liability arising out of the application or use of any product, (ii) any and all liability, including without limitation special, consequential or incidental damages, and (iii) any and all implied warranties, including warranties of fitness for particular purpose, non-infringement and merchantability.

Statements regarding the suitability of products for certain types of applications are based on Vishay's knowledge of typical requirements that are often placed on Vishay products in generic applications. Such statements are not binding statements about the suitability of products for a particular application. It is the customer's responsibility to validate that a particular product with the properties described in the product specification is suitable for use in a particular application. Parameters provided in datasheets and / or specifications may vary in different applications and performance may vary over time. All operating parameters, including typical parameters, must be validated for each customer application by the customer's technical experts. Product specifications do not expand or otherwise modify Vishay's terms and conditions of purchase, including but not limited to the warranty expressed therein.

Except as expressly indicated in writing, Vishay products are not designed for use in medical, life-saving, or life-sustaining applications or for any other application in which the failure of the Vishay product could result in personal injury or death. Customers using or selling Vishay products not expressly indicated for use in such applications do so at their own risk. Please contact authorized Vishay personnel to obtain written terms and conditions regarding products designed for such applications.

No license, express or implied, by estoppel or otherwise, to any intellectual property rights is granted by this document or by any conduct of Vishay. Product names and markings noted herein may be trademarks of their respective owners.